

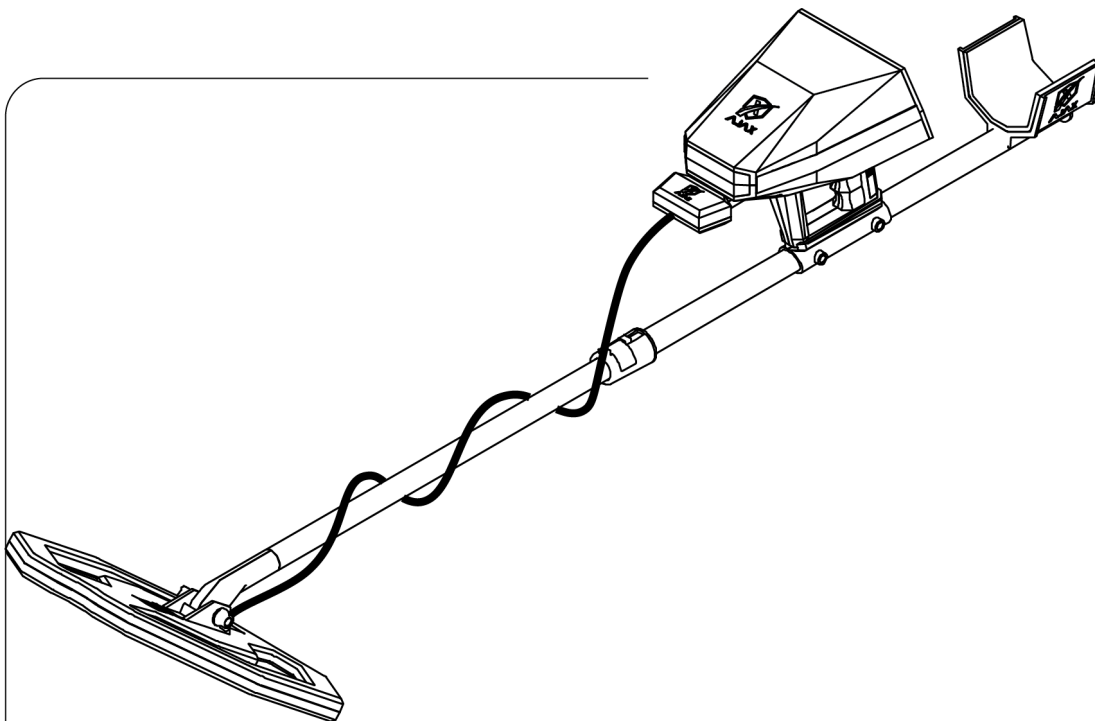

**AJAX**  
DETECTION TECHNOLOGY

# User Manual



**AJAX**

DETECTION TECHNOLOGY

**Primo**

USER MANUAL

No part of this manual, including the products and software described in it, may be reproduced, transmitted, transcribed, stored in a retrieval system, or translated into any language in any form or by any means, except documentation kept by the purchaser for backup purposes, without the express written permission of AJAX DETECTION TECHNOLOGY LTD. (“AJAX”).

Product warranty or service will not be extended if: (1) the product is repaired, modified or altered, unless such repair, modification or alteration is authorized in writing by AJAX; or (2) the serial number of the product is defaced or missing.

AJAX PROVIDES THIS MANUAL “AS IS” WITHOUT WARRANTY OF ANY KIND, EITHER EXPRESS OR IMPLIED, INCLUDING BUT NOT LIMITED TO THE IMPLIED WARRANTIES FOR CONDITIONS OF MERCHANTABILITY OR FITNESS FOR A PARTICULAR PURPOSE. IN NO EVENT SHALL AJAX, ITS DIRECTORS, OFFICERS, EMPLOYEES OR AGENTS BE LIABLE FOR ANY INDIRECT, SPECIAL, INCIDENTAL, OR CONSEQUENTIAL DAMAGES (INCLUDING DAMAGES FOR LOSS OF PROFITS, LOSS OF BUSINESS, LOSS OF USE OR DATA, INTERRUPTION OF BUSINESS AND THE LIKE), EVEN IF AJAX HAS BEEN ADVISED OF THE POSSIBILITY OF SUCH DAMAGES ARISING FROM ANY DEFECT OR ERROR IN THIS MANUAL OR PRODUCT.

SPECIFICATIONS AND INFORMATION CONTAINED IN THIS MANUAL ARE FURNISHED FOR INFORMATIONAL USE ONLY, AND ARE SUBJECT TO CHANGE AT ANY TIME WITHOUT NOTICE, AND SHOULD NOT BE CONSTRUED AS A COMMITMENT BY AJAX. AJAX ASSUMES NO RESPONSIBILITY OR LIABILITY FOR ANY ERRORS OR INACCURACIES THAT MAY APPEAR IN THIS MANUAL, INCLUDING THE PRODUCTS AND SOFTWARE DESCRIBED IN IT.

Products and corporate names appearing in this manual may or may not be registered trademarks or copyrights of their respective companies, and are used only for identification explanation and to the owner’s benefit, without intent to infringe.

# Contents

Safety Information .....	6
Where to find more information .....	6
Introduction .....	7
Specification Summary .....	8
Package Contents .....	9
Overview .....	13
Hard Keys .....	14
Battery Assembly .....	16
Assembly .....	17
Imaging Scanner Assembly .....	18
Search Coil Assembly .....	20
Gradio Smart Assembly .....	21
High Gain Antenna Assembly .....	22
Roaming Antennas Assembly .....	23
Initial setup .....	24
User Interface .....	25
Settings .....	26
Language .....	26
Time and Date .....	26
Display .....	27
Sound .....	28
Power Mode .....	29
Storage .....	30
Bluetooth .....	31
Info .....	32
Security .....	33
Reset .....	34



Quick Settings .....	35
3D Ground Scan .....	36
Device: .....	36
Tablet: .....	41
Tablet Pairing: .....	42
Gradio Smart .....	47
Live Scan .....	52
Ionic Long-Range .....	54
Starting the Search .....	56
Ground Balance .....	57
Locating Target point and checking target .....	58
Depth Measuring .....	60
Save .....	61
Search Coils .....	62
Smart Pulse .....	63
Spectrum Analyzer .....	67
Long-Range Locator .....	71
Manual Long-range Search .....	72
Auto Long-range Search .....	76
Geophysical .....	83
Battery .....	85
Charging the battery .....	85
Precautions for operating environment .....	85
Battery charging tips and precautions .....	86
Contact Information .....	87
WEEE (Waste Electrical and Electronic Equipment) Statement .....	89

## Safety Information

The components included in this package are prone to damage from electrostatic discharge [ESD]. Please adhere to the following instructions to ensure successful device assembly.



Ensure that all components are securely connected. Loose connections may cause the device to not recognize a component or fail to start.

Hold the device firmly when assembling or operating.

It is recommended to discharge yourself of static electricity by touching another metal object before handling the device.

Store the device in an electrostatic free environment whenever the device is not in use.

Do not assemble or operate the device before reading the user manual. This might cause permanent damage to the components as well as injury to the user.



If you need help during installation step, please consult support via phone or Online help-desk.



Always turn off the device before storing the device.

Keep this user manual for future reference.



Keep this device away from humidity.

Make sure that your electrical outlet provides the same voltage as is indicated on the Charger before connecting to the electrical outlet.

All cautions and warning on the device and in the user

manual should be noted.

If any of the following situations arises, get the device checked by service personnel:

Liquid has penetrated into the device.

The device has been exposed to moisture.

The device does not work well or you can not get it work according to user manual.

The device has been dropped or damaged.

The device has obvious sign of breakage.

Do not leave the device in an environment above 60°C (140°F), it may damage the device.



## Where to find more information

Refer to the following sources for additional information and for product and software updates.

### 1. AJAX websites:

The AJAX website provides updated information on AJAX hardware and software products. Refer to the AJAX contact information.

### 2. Optional documentation:

Your product package may include optional documentation, such as warranty fliers, that may have been added by your dealer. These documents are not part of the standard package.

## Introduction

AJAX presents you the most powerful and accurate detection systems with advanced systems and software unprecedented, all this and more in Primero, the first detector in the world, is a truly new scientific revolution that provides you with all resources that you need in search and exploration trips of advanced detection systems with precision, efficiency and innovative research methods for the first time, and through AJAX for detectors technology only, Primero has a unique and modern design which allows you to work on all systems of detection and exploration, also it contains high-level of operating programs and settings which allow you to control the overall plans of your exploratory trips until you reach to your target.

- Ajax Primero contains 9 different systems specialized to detect gold, mineral and buried targets with high-level technological performance and new concepts, these systems give you the accurate results integrated around the target with more specific details.

This device can be used through 9 different detection and exploration systems

- 1- Gradiosmart system
- 2- Live Scan
- 3- 3D Ground Scanner
- 4- Smart Pulse
- 5- Spectrum Analyzer
- 6- Ionic Long Range
- 7- Long Range Locator Automatic
- 8- Long Range Locator Manual
- 9- Geophysical

Thank you for purchasing the AJAX Primero detection device.

This quick Start section provides demonstration about how to assemble your device .

Some of the installations also provide video demonstrations. Please link to the URL to watch it with the web browser on your phone or tablet. You may have even link to the URL by scanning the QR code.

## Specification Summary

AJAX Detection Technology has been working on an innovation in detection field to expand the horizons and opportunities for new experience leading to efficient work-flow.

Research Principle	Multi-detection systems and functions, contains 9 optional systems
Operating Principle	Processing data and digital signals and converting them to visual and audible results
Processor Architecture	MIPS 32
Operation processor	M4K™ Core
Display Screen	TFT Color LCD, 800 x 480 WVGA, 16-bit color depth
Battery	7.4 volts, 3300 mAh
Power Rating	400 mA
Battery Endurance	Typical usage time 10 hours*
Power Adapter	240-100 VAC / 15 VDC - EU Plug
Storage	1 GB / it can save to 1000 scans.
Sound	High quality sounds, 32 KBIT/S, MP3
Notifications	Sound and tactile feedback configurable in the settings menu for
Bluetooth	2.4 GHz, sensitivity up to -80dBm.
Languages	Multilingual User Interface with support for 8 languages.
Date and Time	Real Time Clock could be set manually or Automatically via GPS time.
Login Restriction	Configurable PIN.
Dimensions	145x45x24 cm
Overall Dimensions	88x52x20 cm
Package Total Weight	8 kg
Assembly Weight	1 Kg (~2 lbs) ; 1.7 Kg (~3.75 lbs)
Operating temperature	From -10° C to 60° C (14° F - 140° F)
Storage temperature	From -10° C to 80° C (14° F - 176° F)
Humidity	Could be stored and operated at relative humidity level up to 90%.

\*- Typical battery endurance is subjected to battery life degradation and environmental factors.

# Package Contents

---

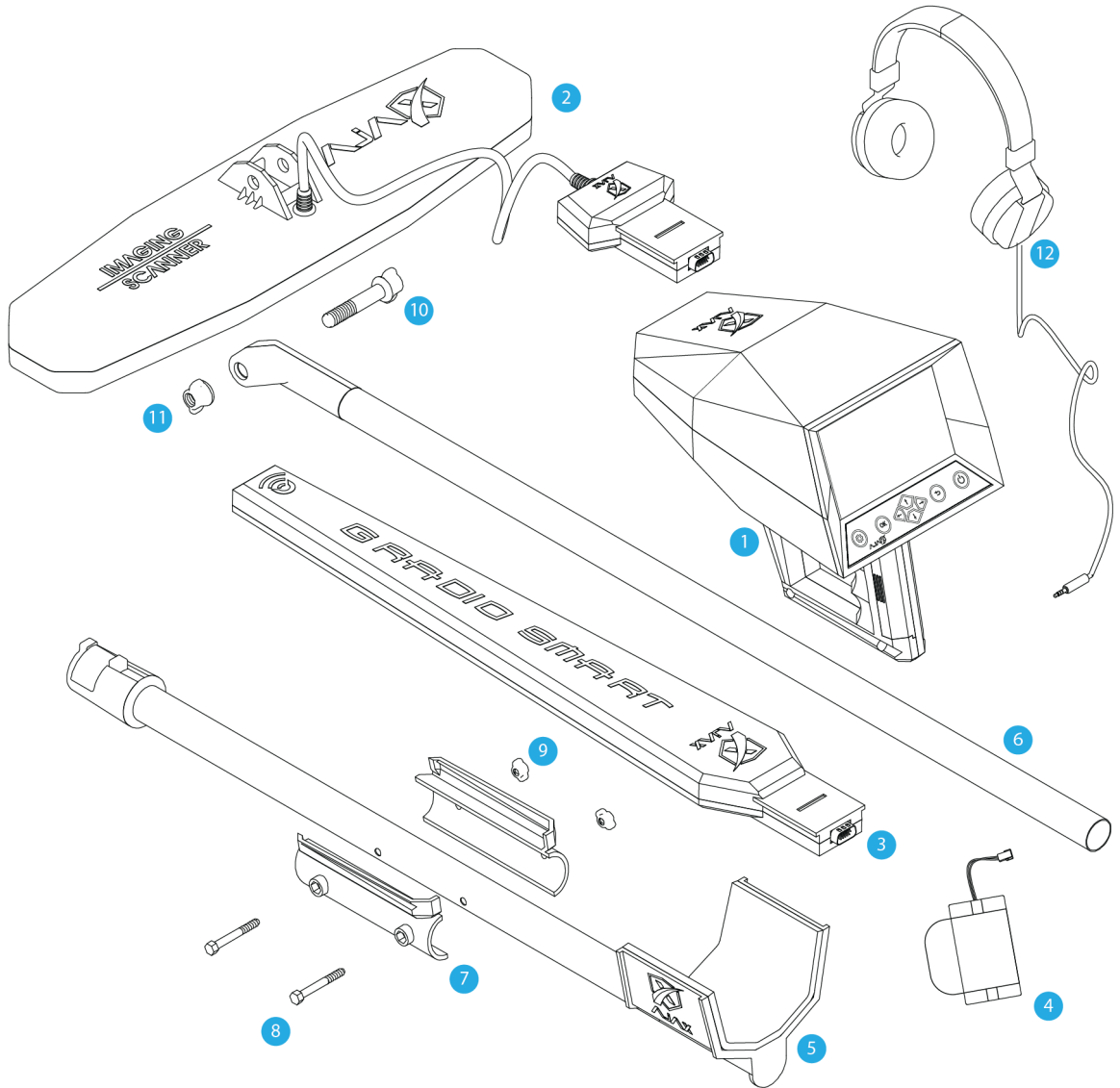

## Package Contents

---

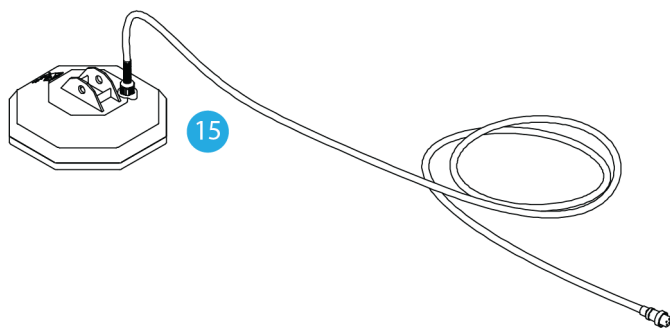
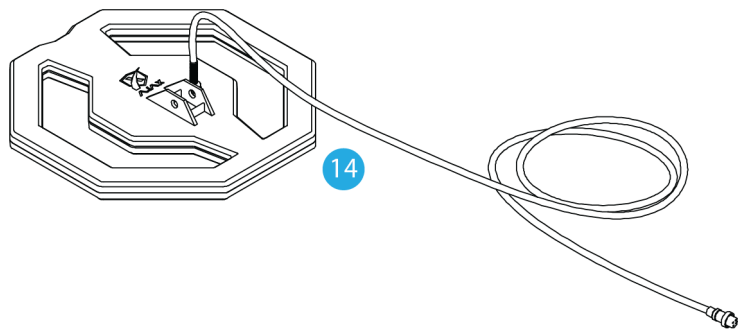
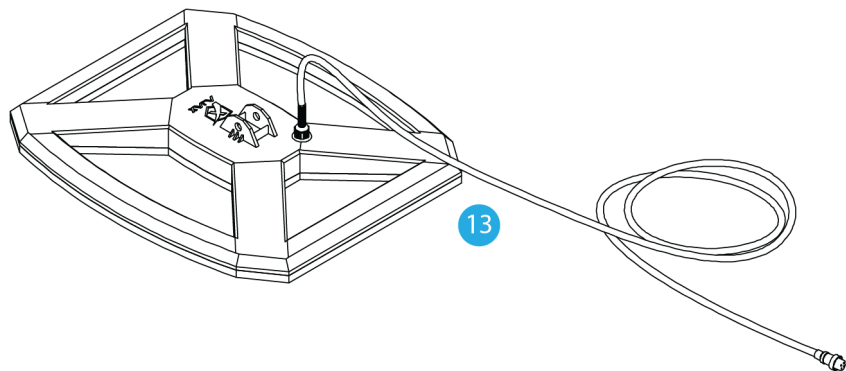

# Package Contents

---

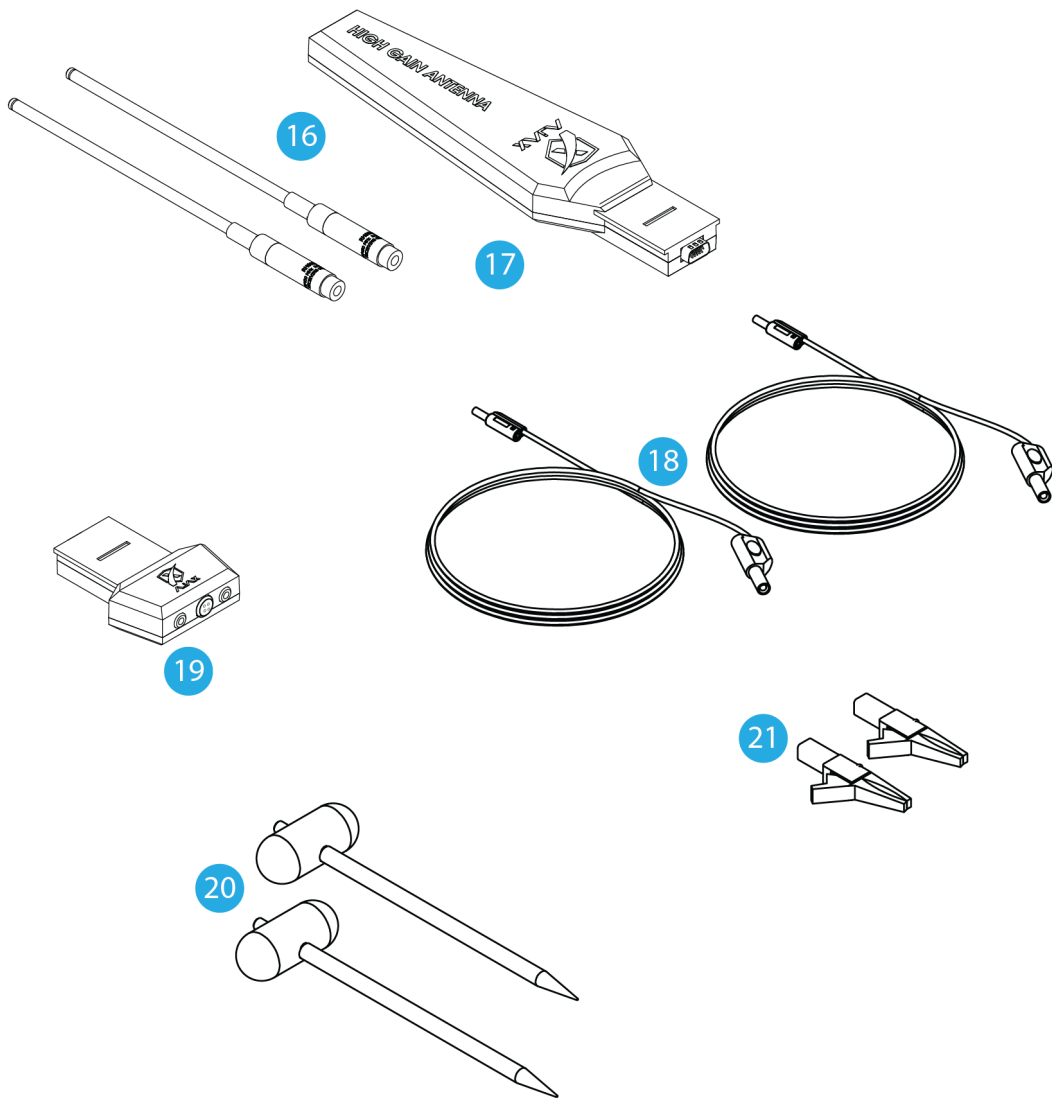

## Package Contents

---

Check your device package for the following items:

<b>1</b>	Main Unit
<b>2</b>	Imaging Scanner
<b>3</b>	Gradio Smart Sensor
<b>4</b>	Battery Pack
<b>5</b>	Carrying Pole
<b>6</b>	Extension Pole
<b>7</b>	Device Clamp
<b>8</b>	Clamp Bolt x2
<b>9</b>	Clamp Nut x2
<b>10</b>	Bolt
<b>11</b>	Nut
<b>12</b>	Headphones

<b>13</b>	C3 Search Coil
<b>14</b>	C2 Search Coil
<b>15</b>	C1 Search Coil
<b>16</b>	2x Roaming Antenna
<b>17</b>	High Gain Antenna
<b>18</b>	Connection wires
<b>19</b>	System Connection Module
<b>20</b>	Ground Scan Probes x2
<b>21</b>	Connection Clips x2

- The items supplied with the device and any available accessories may vary depending on the region or service provider.
- The supplied items are designed only for this device and may not be compatible with other devices.
- Appearances and specifications are subject to change without prior notice.
- You can purchase additional accessories from your local AJAX retailer. Make sure they are compatible with the device before purchase.
- Use only AJAX-approved accessories. Using unapproved accessories may cause the performance problems and malfunctions that are not covered by the warranty.
- Availability of all accessories is subject to change depending entirely on manufacturing companies. For more information about available accessories, go to the AJAX website.



## Overview

---

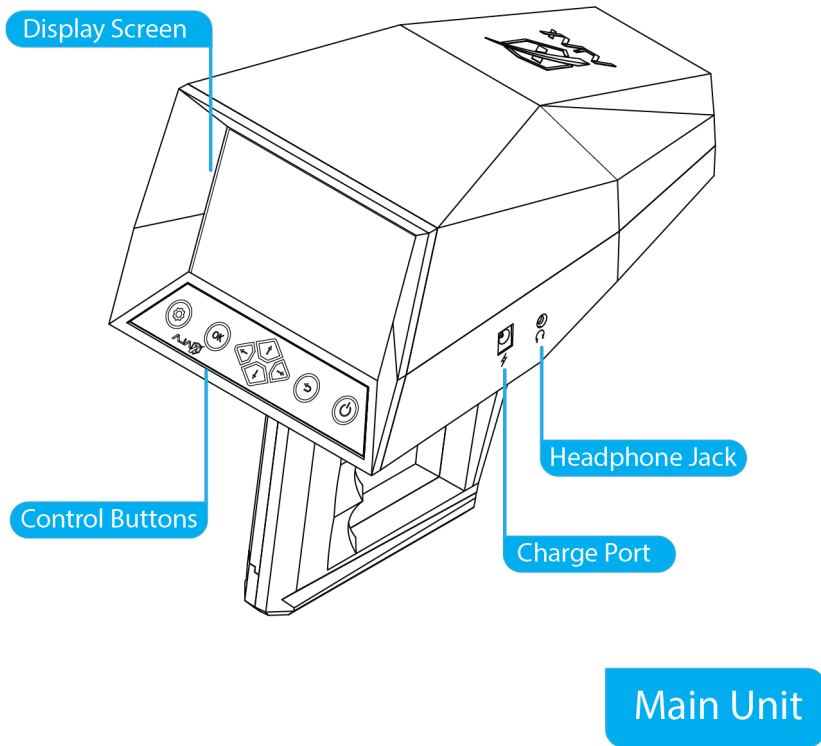

# Hard Keys

---

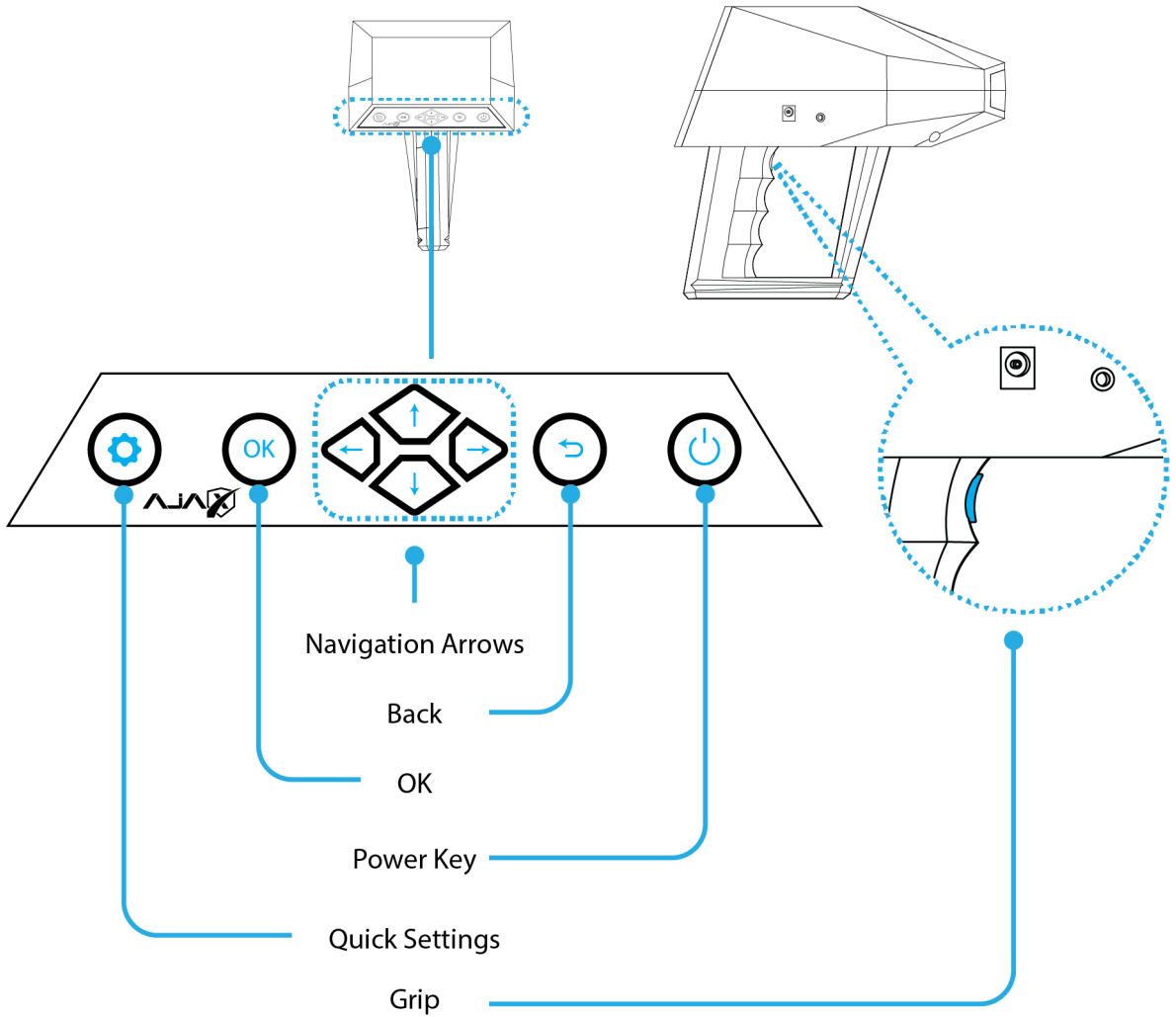

## Hard Keys

---

Key	Function
Power	<ul style="list-style-type: none"><li>• Press and hold to turn the device on or off.</li><li>• Press to turn on or lock the screen.</li></ul>
OK	<ul style="list-style-type: none"><li>• Confirm/enter the selected option.</li></ul>
Back	<ul style="list-style-type: none"><li>• Go to previous menu, cancel.</li></ul>
Navigation Keys	<ul style="list-style-type: none"><li>• Navigation through the device interface.</li></ul>
Quick Settings	<ul style="list-style-type: none"><li>• Press to drop the quick settings menu.</li></ul>
Grip Key	<ul style="list-style-type: none"><li>• Multi-purposed key for ease of access while searching.</li></ul>

### Turning the device on and off

Press and hold the Power key for a few seconds to turn on the device.

When you turn on your device for the first time or after performing a data reset, follow the on-screen

Instructions to set up your device.

To turn off the device, press and hold the Power key, and then tap Power off.

Follow all posted warnings and directions from authorized personnel in areas where

The use of wireless devices is restricted, such as airplanes and hospitals.

## Battery Assembly

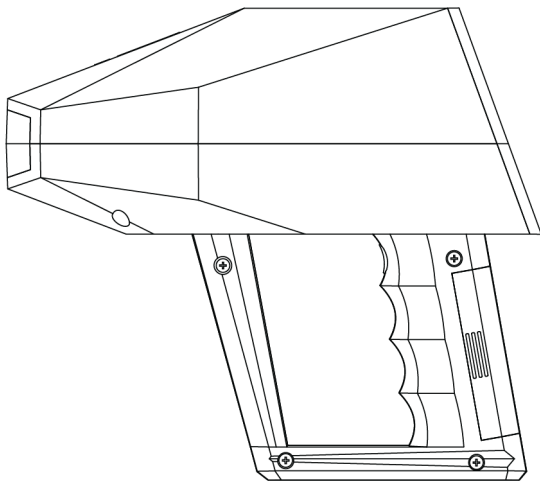
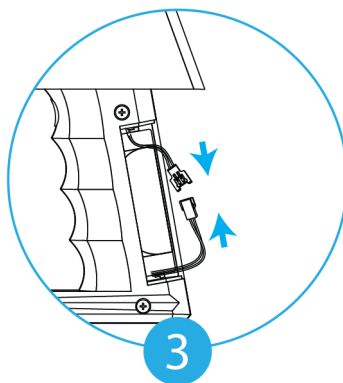
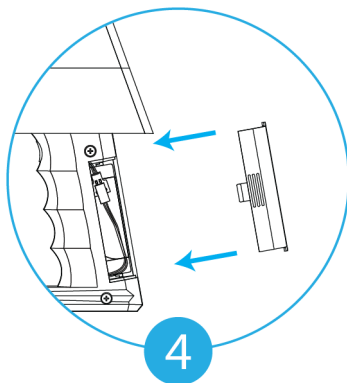
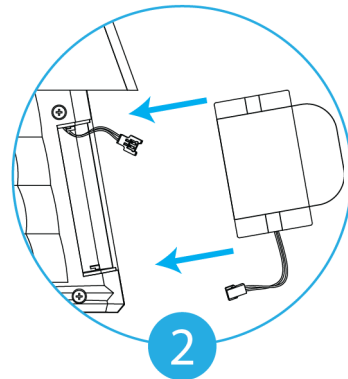
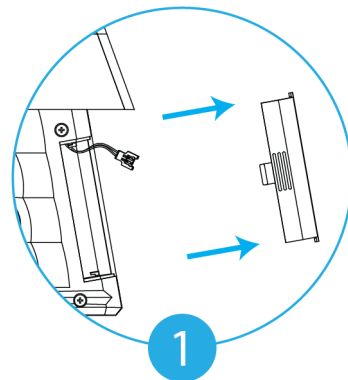

figure 1 -Battery Assembly



- 1- Press firmly at the ridges and push outwards to remove the battery cover.
- 2- Insert the battery pack inside the compartment.
- 3- Connect the wires and make sure they are securely attached.
- 4- Insert the connector inside the compartment and put the cover back on the grip.

# Assembly

---

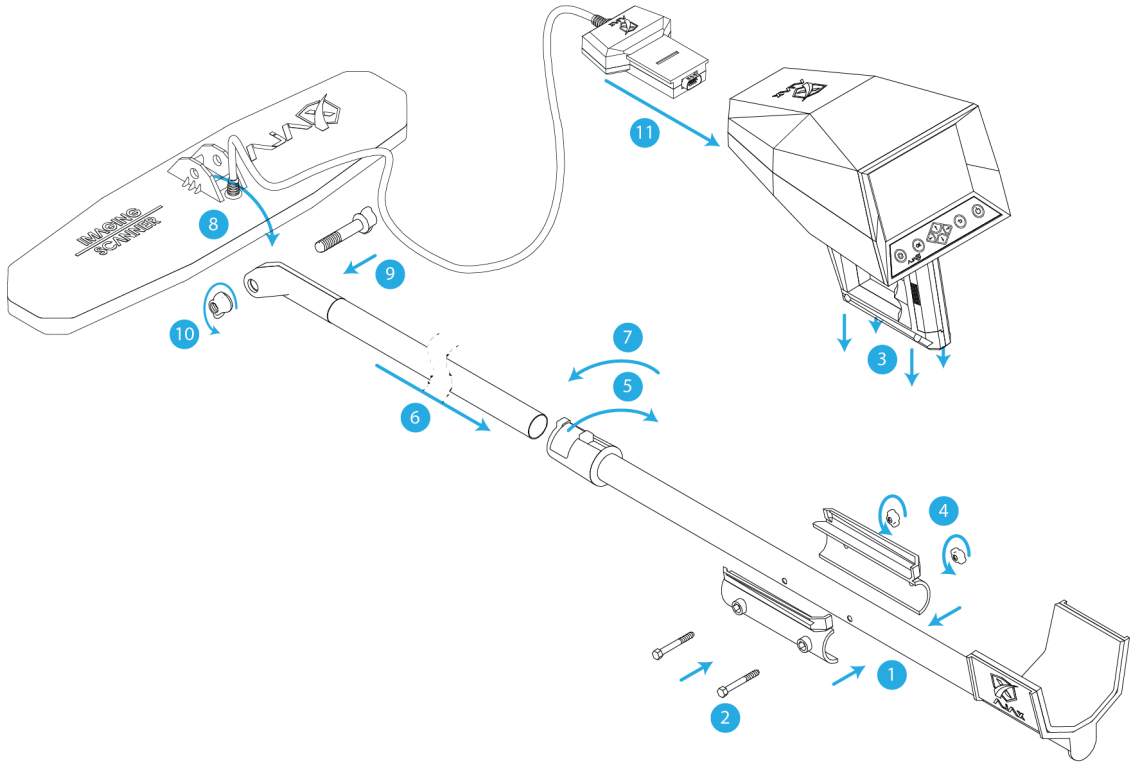

figure 2 -Imaging Scanner Assembly

# Assembly

## Imaging Scanner Assembly

- 1- Align the clamp with the holes on the pole.
- 2- Insert the screws into the clamp.
- 3- Put the Main Unit inside the clamp.
- 4- Put the nuts on the screws and tighten them.
- 5- Unlatch the pole lock.
- 6- Insert the second pole and adjust the length.
- 7- Lock the latch back in securely.
- 8- Align the Imaging Scanner with the second pole tip.
- 9- Insert the screw.
- 10- Adjust the Imaging Scanner angle and tighten the nut.
- 11- Wrap the cable around the second pole and insert the connection module in the front of the Main Unit.

# Assembly

---

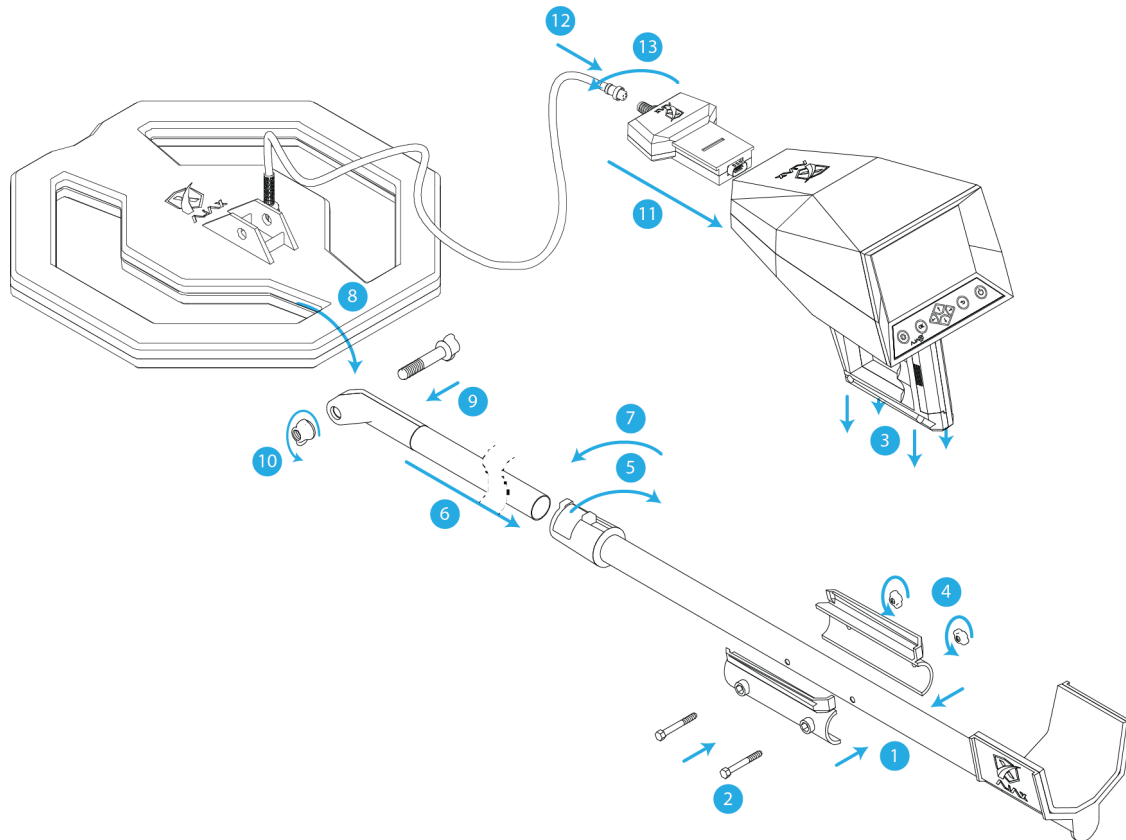

figure 3 -Search Coil Assembly

## Assembly

### Search Coil Assembly

- 1- Align the clamp with the holes on the pole.
- 2- Insert the screws into the clamp.
- 3- Put the Main Unit inside the clamp.
- 4- Put the nuts on the screws and tighten them.
- 5- Unlatch the pole lock.
- 6- Insert the second pole and adjust the length.
- 7- Lock the latch back in securely.
- 8- Align the Search Coil with the second pole tip.
- 9- Insert the screw.
- 10- Adjust the Search Coil angle and tighten the nut.
- 11- Inset the connection module in front of the main unit.
- 12- Wrap the cable around the second pole
- 13- Insert the connector into the connection module in the front of the Main Unit and tighten it .



## Assembly

---

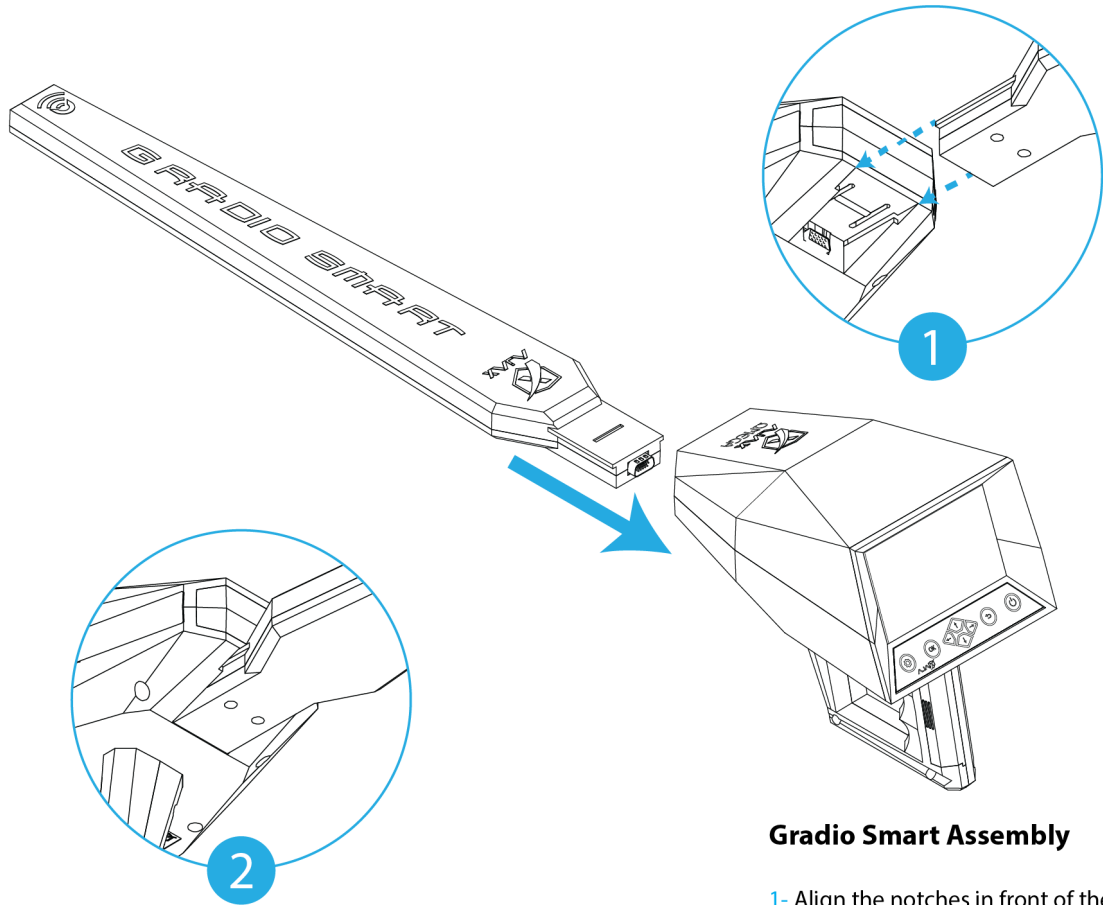

*figure 4 -Gradio Smart Assembly*

### **Gradio Smart Assembly**

- 1- Align the notches in front of the device with the back of the Gradio Smart Module.
- 2- Press firmly until the Module is secured back into the device.

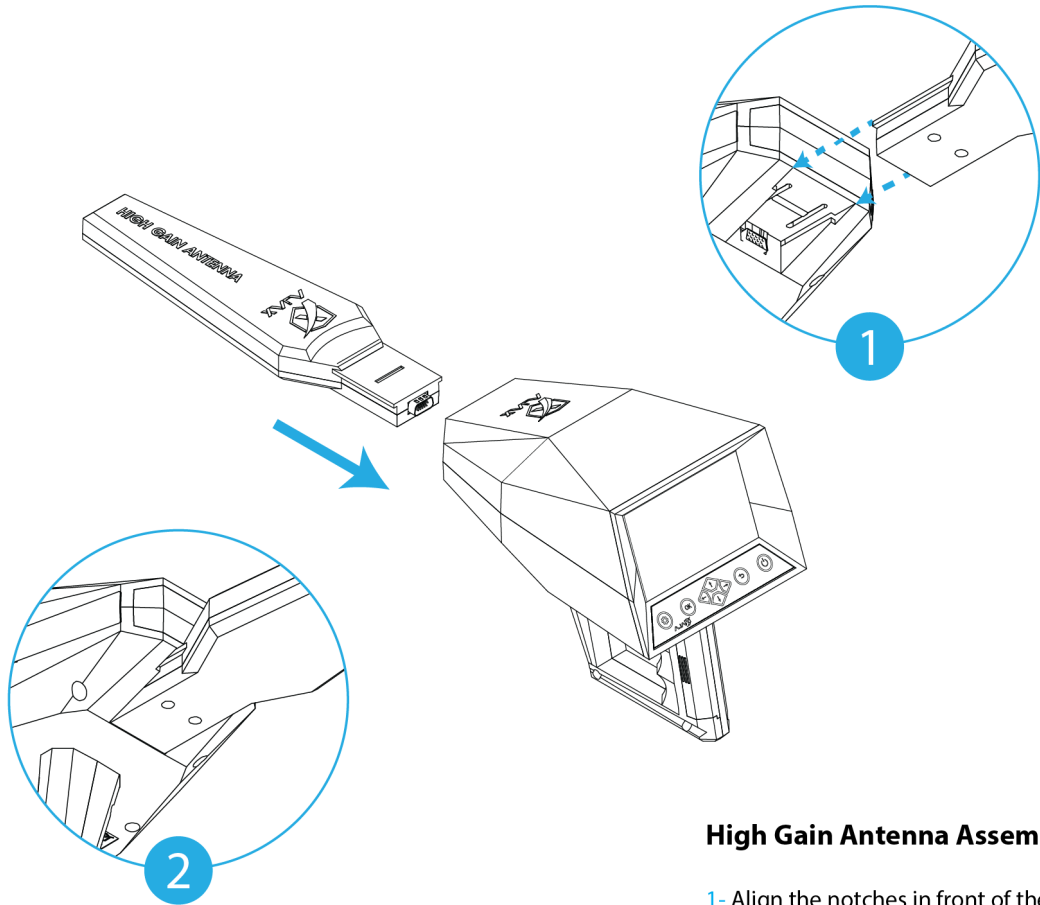

*figure 5 -High Gain Antenna Assembly*

## High Gain Antenna Assembly

- 1- Align the notches in front of the device with the back of the High Gain Antenna.
- 2- Press firmly until the Antenna is secured back into the device.

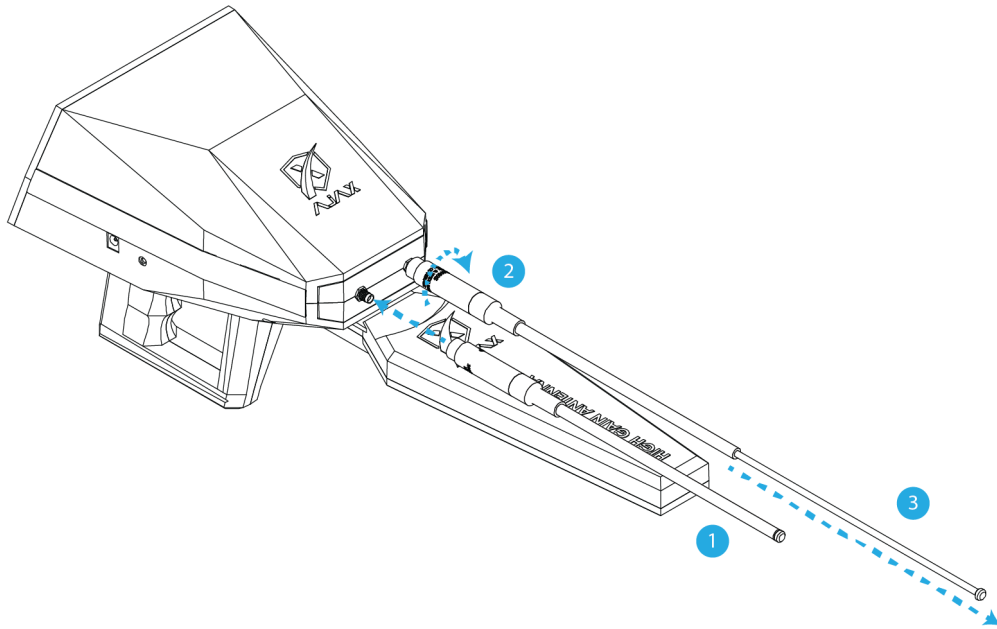

*figure 6 -Roaming Antennas Assembly*

## **Roaming Antennas Assembly**

- 1- Insert the antennas into the connectors located in front of the main unit.
- 2- Screw the antennas into the connector securely.
- 3- Grab the tip of the antenna and extend it.

## Initial setup

When you turn on your device for the first time or after performing a data reset, follow the on-screen instructions to set up your device.

- The initial setup procedures may vary depending on the device's software and your region.



**1** Turn on the device.

Press and hold to turn the device on

**2** Select a language.

Select your preferred device language and select .

**3** Set Time and Date.

Press   to move, and  to change values.

After setting the parameters the Main Menu will show on the display.

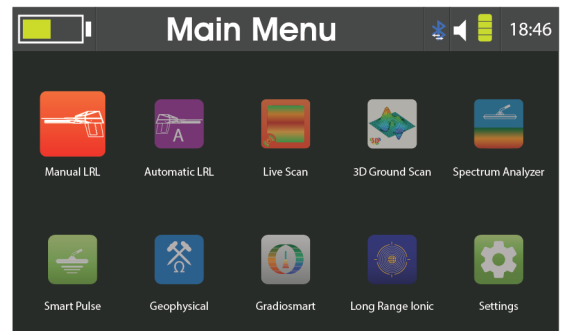
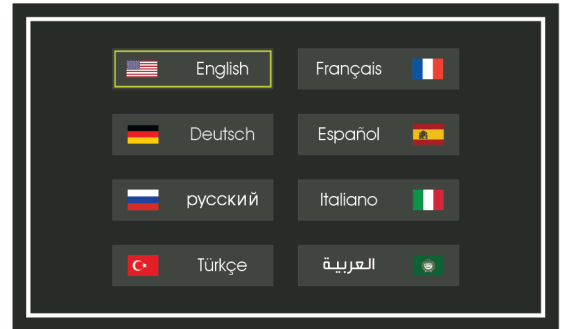

*Note:*

The time format is 24h (hh:mm) e.g. 19:42

The date format is day/month/year (DD/MM/yyyy) e.g. 30/03/2018.

# User Interface

---

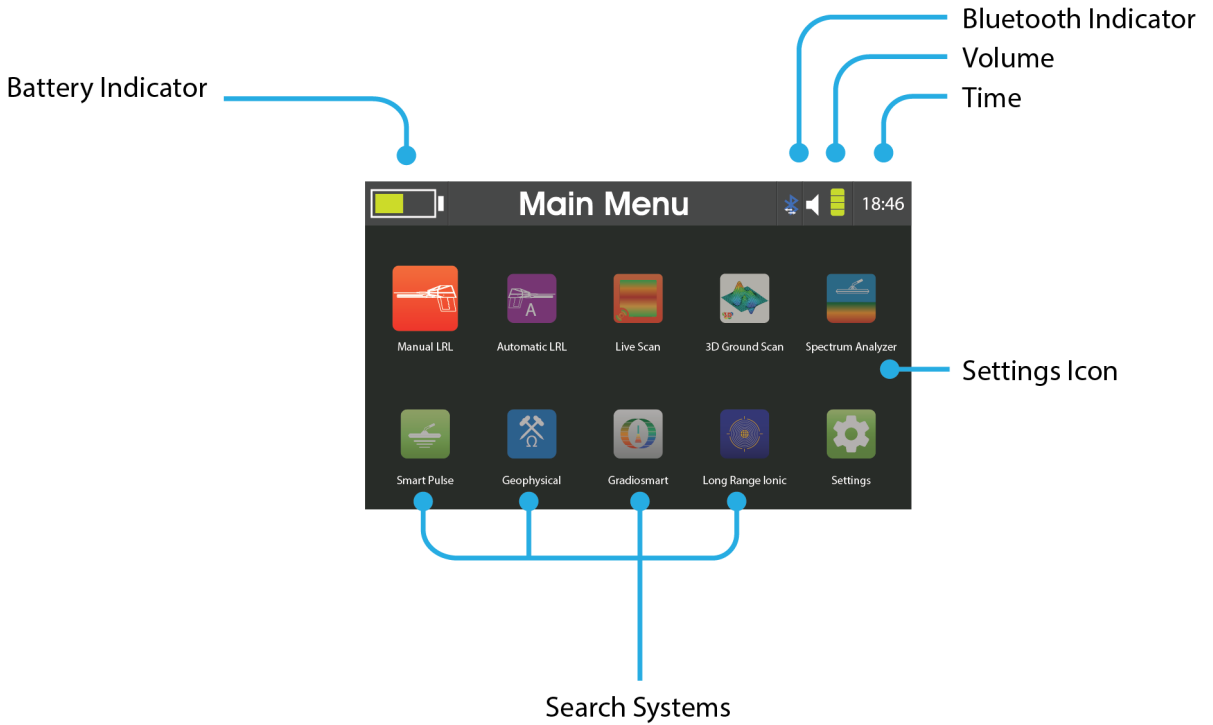

# Settings

---



## Language

The device supports 8 different languages for the interface (English, French, German, Spanish, Italian, Russian, Turkish and Arabic)

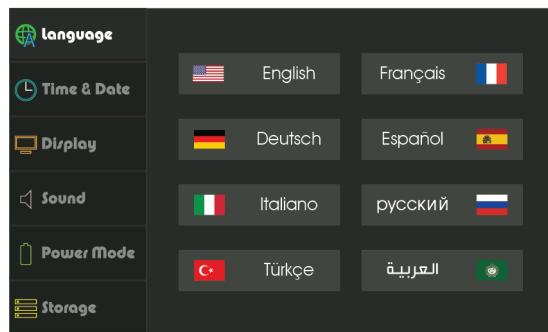
Select language and press  to set the language to the device.



## Time and Date

Press   to move, and  to change values.

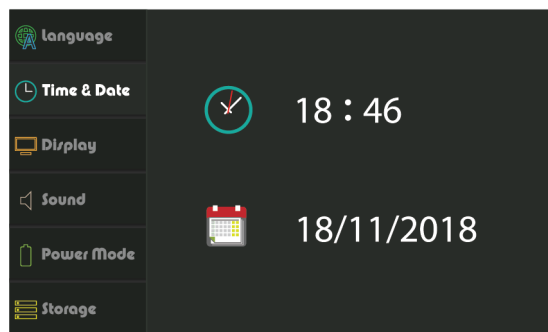

*Note:*

The time format is 24h (hh:mm) e.g. 19:42

The date format is day/month/year (DD/MM/yyyy) e.g. 30/03/2019.

# Settings

---

## Display

### Brightness:

Move the brightness slider to adjust the brightness.  
The value is adjustable from 0 to 100% brightness in a 1% increments.  
Maximum brightness is 250 nits.

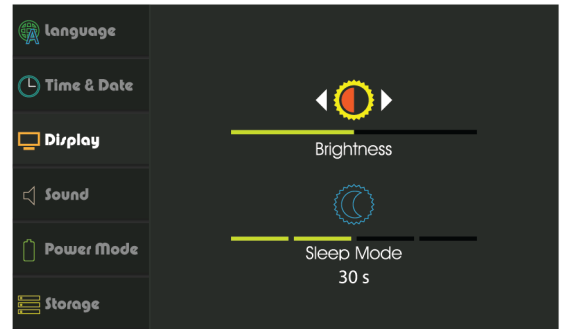

### Sleep Mode:





Set the automatic dimming for the brightness in order to preserve power.

This setting could be set to 15, 30, 45 or 60 seconds, or it could be turn off completely.

# Settings



---

## Sound

Press   to move the cursor, press   to change values, and press  to change mode.

### I- General Volume:

This setting controls the volume for the notifications, errors, and the starting audio.

To set volume press  , and press  to change mode.

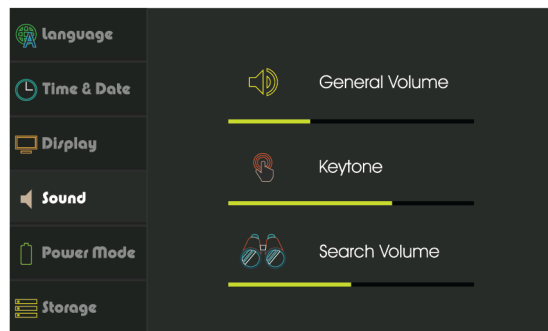

#### 1- General mode

The device will respond with vibration in addition to sound.



#### 2- Silent mode

The device will not respond with any type of feedback



#### 3- Vibration mode

The device will only respond with vibration feedback



#### 4- Normal mode

The device will only respond with sound feedback

### II- Key-tone:

This setting controls the volume for the feedback of pressing the buttons.

To set volume press  .

### III- Search Volume:

This setting controls the volume for search results and readings.

To set volume press  .

### Note:



*The key-tone volume and search volume are not set by the general volume.*



# Settings

---

## Power Mode

This menu shows the power state of the device and current power mode, to change power mode move the cursor   and press  to confirm.

*I- Power Saving mode:*



This mode saves power by disabling idle modules in order to preserve power for long search operations.

*II- Optimum Mode:*



This mode will set the device with all modules on for a steady performance operation.

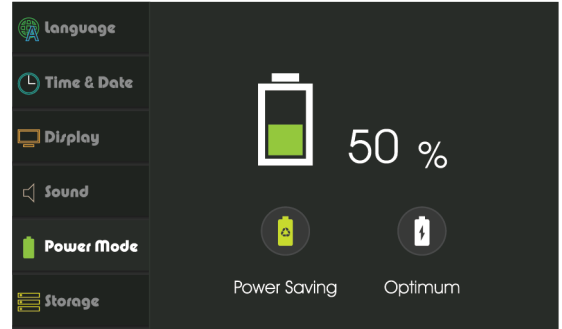



# Settings

---

## Storage

This menu shows the previously saved search results.

The user can view or delete the results.

Press   to select which system results to show.

Then the results list shows the saved searches

Navigate the list and press  to view or delete the highlighted result.

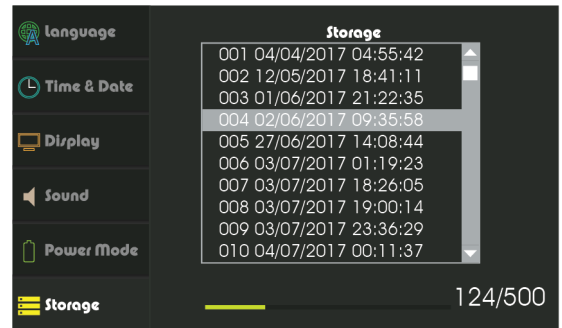
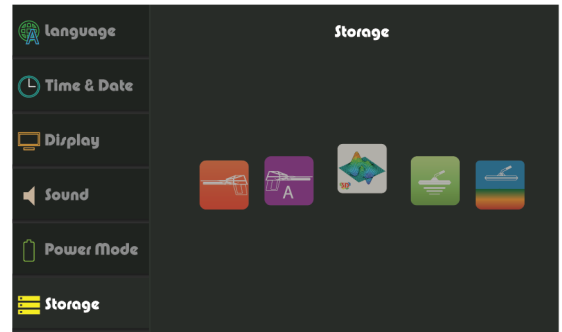



# Settings

---

## Bluetooth

This menu shows Bluetooth state.

To change state press   then  or  to activate .

To change state navigate to the toggle and press ,  to activate or  to deactivate.

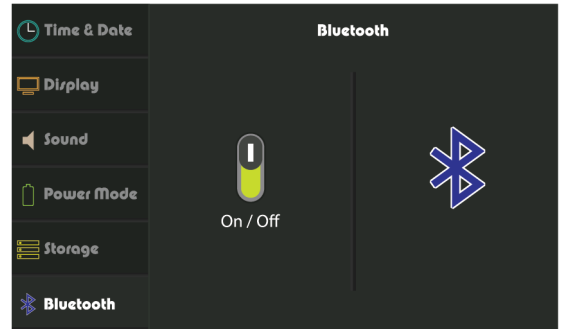

# Settings

---

## Info

This menu shows:

Device Version  
Software Version  
Model  
Uptime

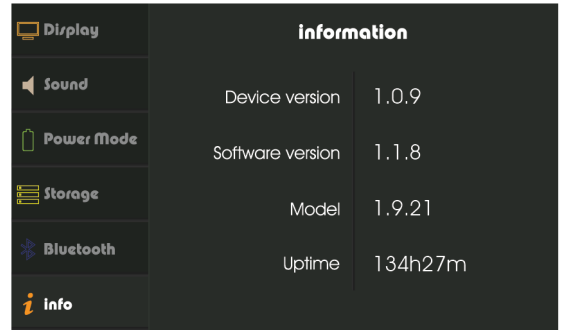

# Settings



---

## Security

This menu shows Secure Start state.

To change state press   then  or  to activate .

To change state navigate to the toggle and press

,  to activate or  to deactivate.

Enter a new PIN then press .

Enter the PIN again for confirmation.

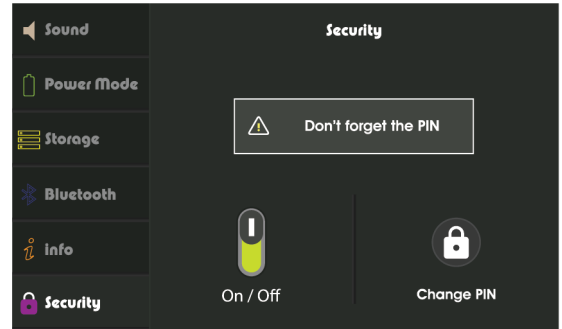

# Settings

---

## Reset

This menu shows the reinitializing options.

### *I- Clear Memory:*

This option erase all saved results from memory.

### *II- Reset settings:*

This option resets all the settings to default values.

### *III- Factory Reset:*

This option resets all the settings to default values and erase all saved results.

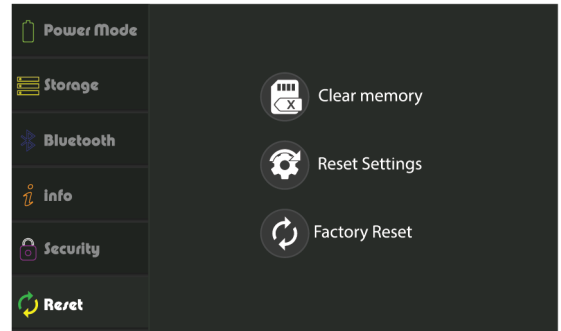





## Quick Settings

---



To access the quick settings menu, press  key on the far left of the keypad.

When pressed, the title in the status bar will be replaced with the settings icons.

Press   to navigate through the options.







 Display Brightness. It can be set by pressing  to decrease or  to increase the brightness intensity.



 Sleep mode. It can be set to 5 settings 15, 30, 45 or 60 seconds or be set off completely.



 Power mode. It can be set by pressing  to change the power mode into:

 Optimum mode

 Power save mode

 Sound. Press  to increase or  to decrease the current value, while pressing  will change the sound value for the device keys  or the search .

"18:46" Time. Set the current time by pressing  or .

*Note: To exit the quick settings menu press  or . The quick settings menu is accessible in every menu with a visible status bar.*

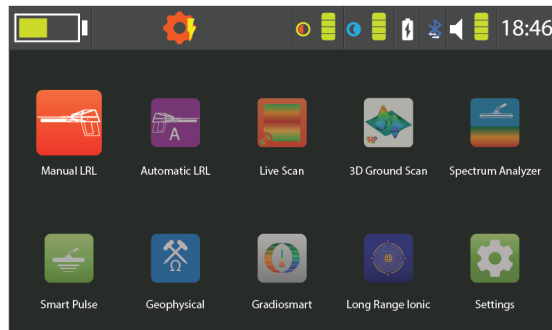

## 3D Ground Scan

Select  3D Ground Scanner from the main menu and make sure the device is assembled as shown in “figure 2 -Imaging Scanner Assembly” on page 17.

Select the viewing scope:  
Device or **Tablet**

### Device:

Set the scan parameters

Scan Mode:

**Automatic Mode:** This mode takes a reading every one second without the need to press the grip button.

**Manual Mode:** This mode takes a reading with each press on the grip button.

Scan Path:

**One Direction :** The scan steps start from the bottom of the scan grid going up for every column.

**Alternative:** The scan steps change direction after each column scan is done.

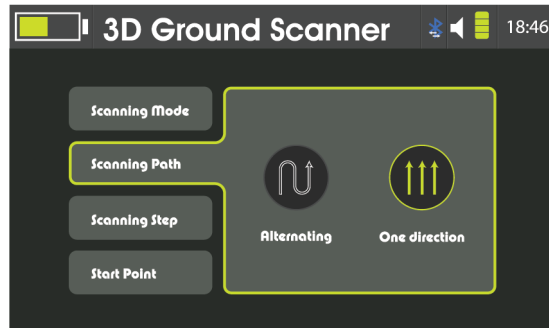
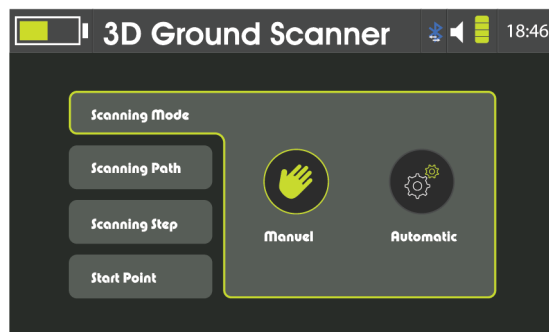
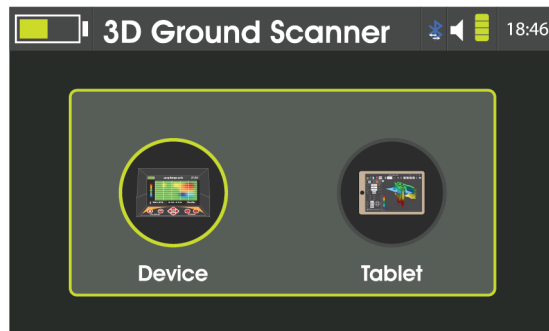



## 3D Ground Scan

---

Scan Step:

Set the scan grid parameters

Columns: The scan steps in parallel with the device during the scan process. The columns could be set to 2-10.

Rows: The scan steps that are perpendicular with the device during the scan process. The rows could be set to 2-20.

Start Point:

Sets the start point of the scanning process left or right. The start point is always located in the bottom of the scanning grid.

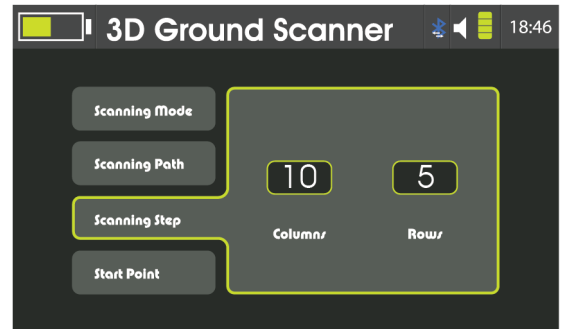

Note:

It's highly recommended to keep the scanning cell size a 60x30 cm ~(2ftx1ft)

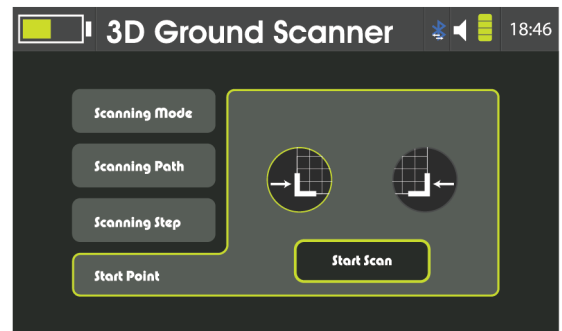

## 3D Ground Scan

Once all the scan parameters are set, perform a balance operation. To balance the device, hold it while the Imaging Scanner is 10-15 cm away from the ground and press the grip key while moving over a neutral area until the bar is filled on the interface.

Position the device at the start point of the scan area and press the grip key to start. Each reading fills a cell on the interface.

Once the column is finished proceed to the next one according to the selected scan path. When the scan area is fully covered the device will process the data.

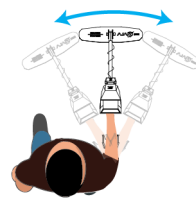
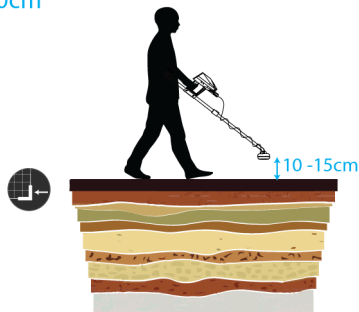
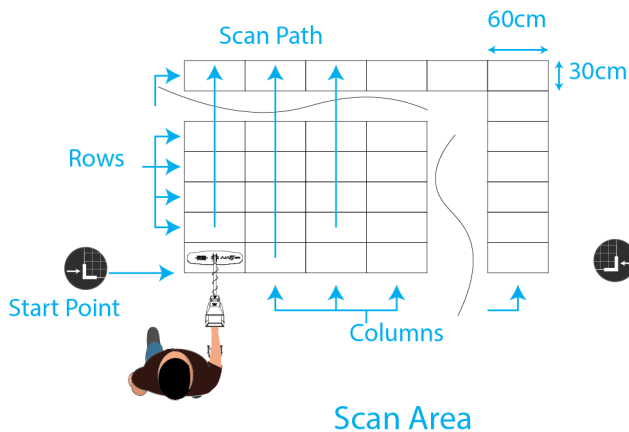
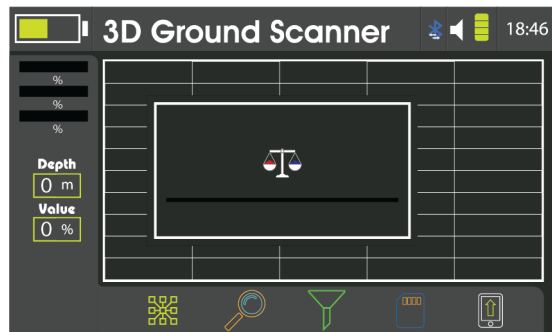

# 3D Ground Scan

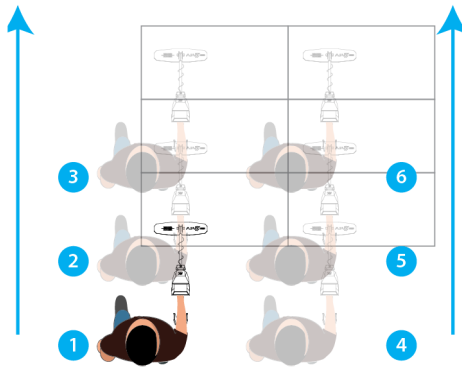

One Direction Scan Path

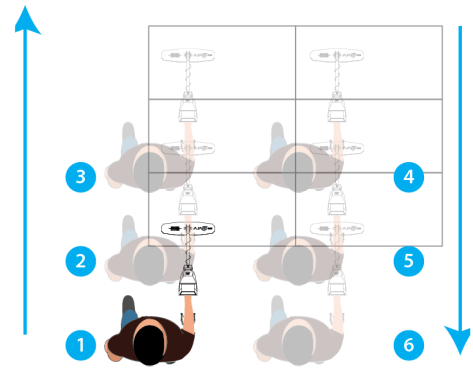

Alternating Scan Path

*Note:*  
The Device orientation must be sustained regardless of the Scan Path.

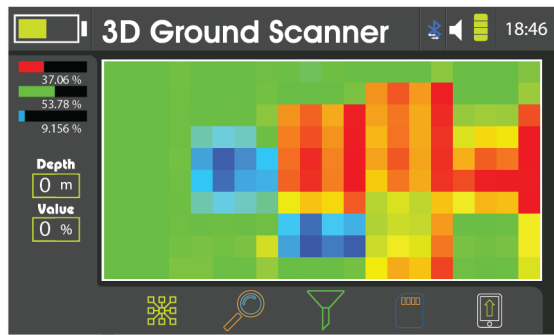

## 3D Ground Scan

---

The Scanning Interface consists of:

**The scanning grid:** The grid shows the columns, rows, Scan Path and the current readings on display.

**Processing Indicator:** It shows state of image processing.

**Filtering:** It enables isolating or hiding a spectrum of readings.

**Details:** It enables the user to review a single cell details and reading values.

**Connectivity:** It shows current state of connection for the Imaging Scanner module.

**Save:** It saves the scan result into the memory for future review.

**Upload:** Sends the scan data to Ajax Analyzer App for interactive 3D representation of the scan.

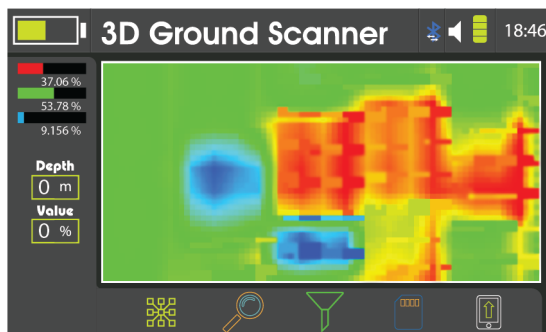

*Note:*

Make sure that the Bluetooth is activated before uploading the data to the AJAX Analyzer App. Bluetooth can be activated via Quick Settings.

## 3D Ground Scan

### Tablet:

Set the scan parameters

Scan Mode, Scan Path, Scan Step and Start point are all the same as previously explained.

Once all the parameters are set and ready to go.

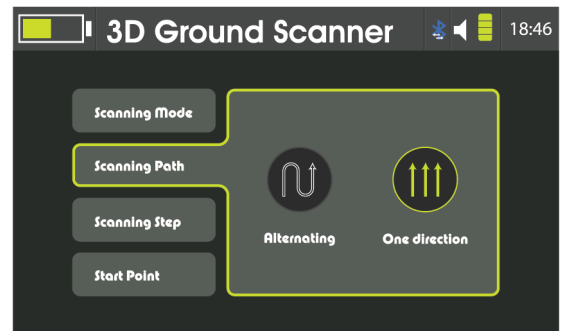
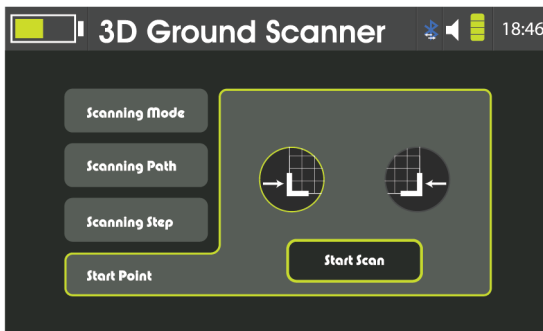
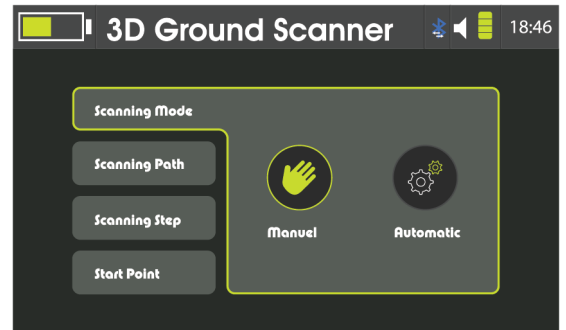
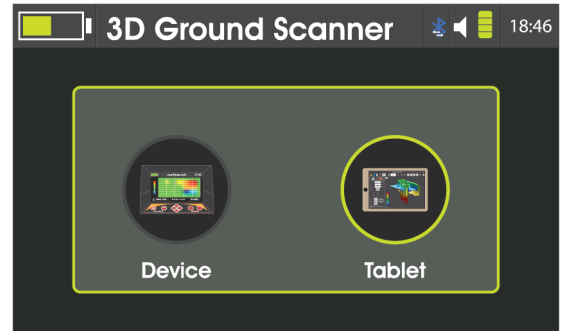

# 3D Ground Scan

## Tablet Pairing:

Once the ground balance process is over, wait for the data to be processed and turn on the Bluetooth if it is off.

A window prompting the connection to the tablet shows next.

On the tablet go to settings.

Go to Connections.

Turn ON Bluetooth.

If it is the first time connecting the device to the tablet, a pairing process is needed.

Search for nearby devices and wait for the device to be listed in the available devices list.

Tap on "AJAX" to pair it  
Enter 1234 as a PIN. Code

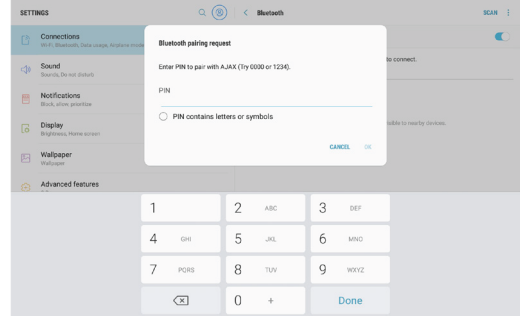
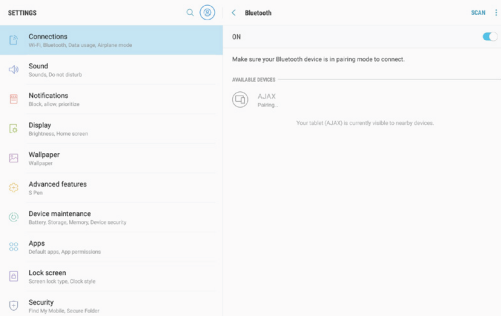
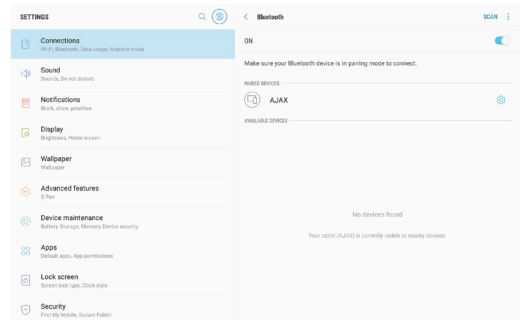
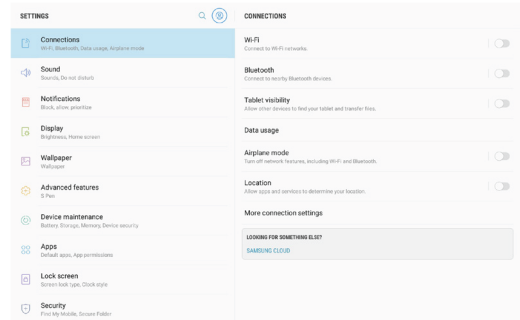

## 3D Ground Scan

Once the pairing process is done successfully launch the Ajax Analyzer app.

Tap the connect button at the upper-left corner and wait for the connection to be established.

A window prompting the start of the scan shows.

Start the scan process with the selected parameters as explained earlier in the device scan.

When the scan process is finished, enter a name for the scan at the upper-right box and tap save.

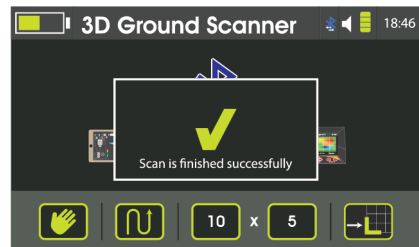
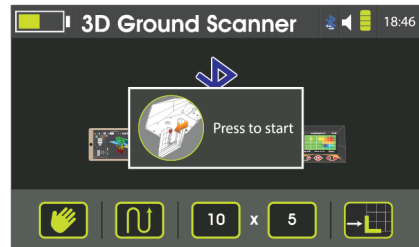
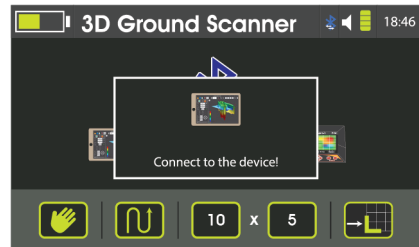
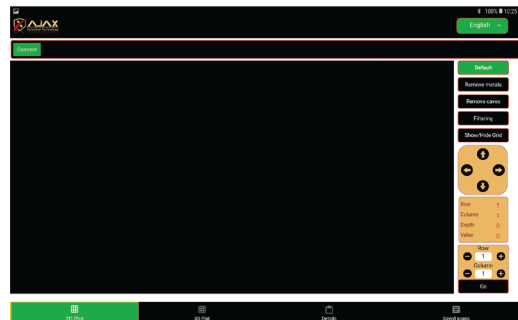
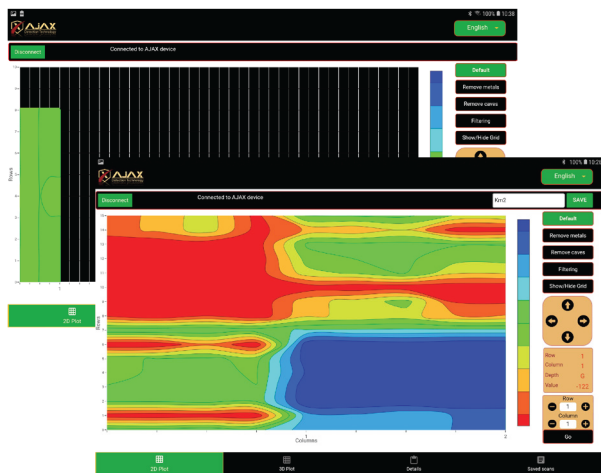

## 3D Ground Scan

1- Specific scan values can be filtered out of the display by the buttons on the right.

Default: shows the full scan data.

Remove Metal shows the scan data and filters out the metal values.

Remove Caves: Shows the scan data and filters out the cavity values.

2- Filtering: The visualization can be smoothed using the Filtering feature to show a gradient view of the scan.

3- To show a specific cell value, use the arrows to locate it. The cell values are shown on the right.

4- Direct input for the cell position can also be made at the bottom of the right, Enter the row and column then tap go to locate the cell directly.

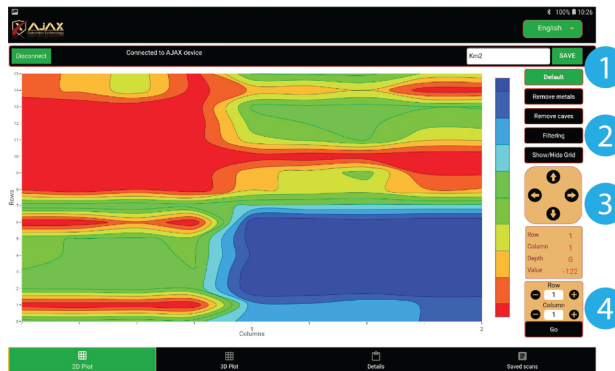



## 3D Ground Scan

The 3D plot shows a three-dimensional surface representing the scan data values.

Different views can be selected from the right, as filtering out metals or caves values.

Swipe over the surface for a custom viewing angle.

Details show the scan information including the scan parameters selected by the device, scan date, scan direction, overview of the values and the scan location.

The scan location is not stored by default.

To store the location of the scan, enable the location services from the settings in the tablet and tap on Show/Refresh current location.

Saved Scans shows a list of the stored scanned for review and analysis.

The Tablet Scan is identical to the Device scan but features an easier interface with a clearer representation and enable the user to scan a larger area of ground.

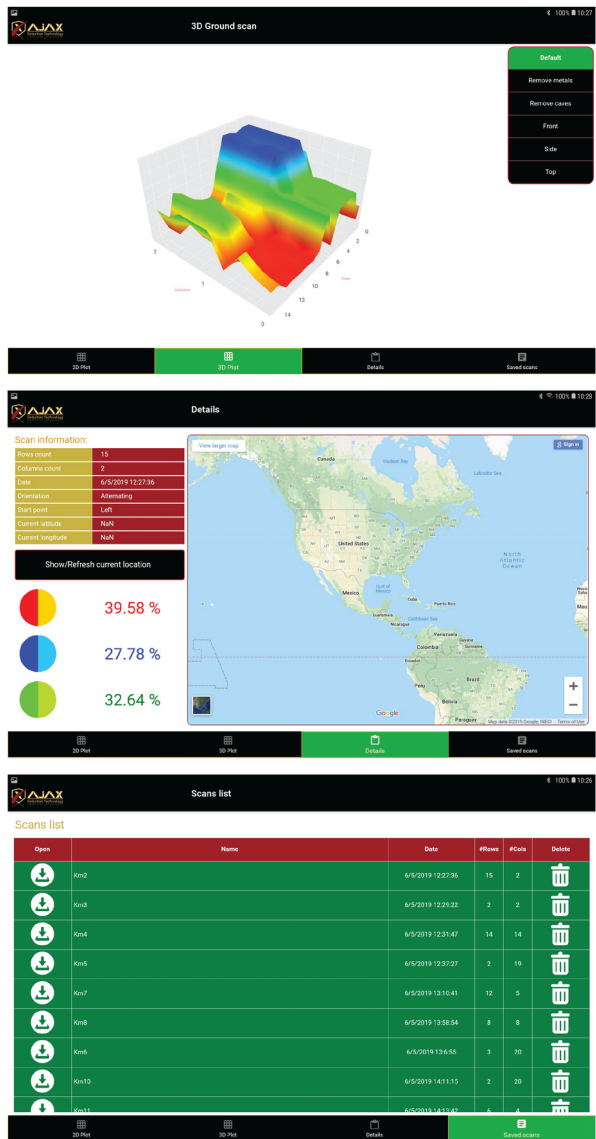



## Gradio Smart

---

Select Gradio Smart from the Main Menu and press  to enter the Gradio Smart search system interface. Make sure that the device is assembled as in “figure 4 -Gradio Smart Assembly” on page 21.

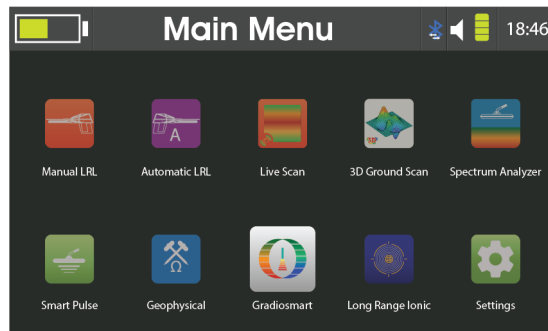

A balancing operation is required before the start of the search in order to nullify external environmental factors.

To perform a balance, point the device towards the ground then press and hold the grip key, while pressing the grip key move over the scan area in a random fashion until the progress bar on the display is filled.

Keep the distance from the tip of the device to the ground surface a 10-15 cm (4-6 in) throughout the whole balance operation.

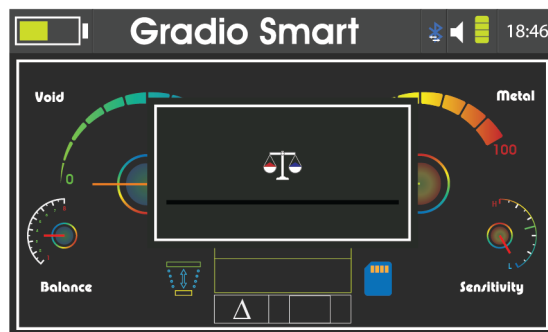

# Gradio Smart

---

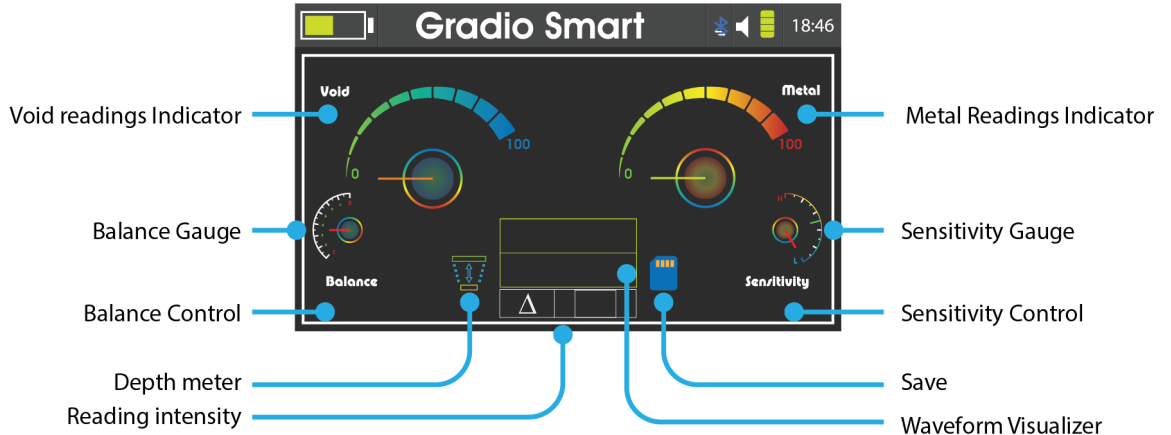

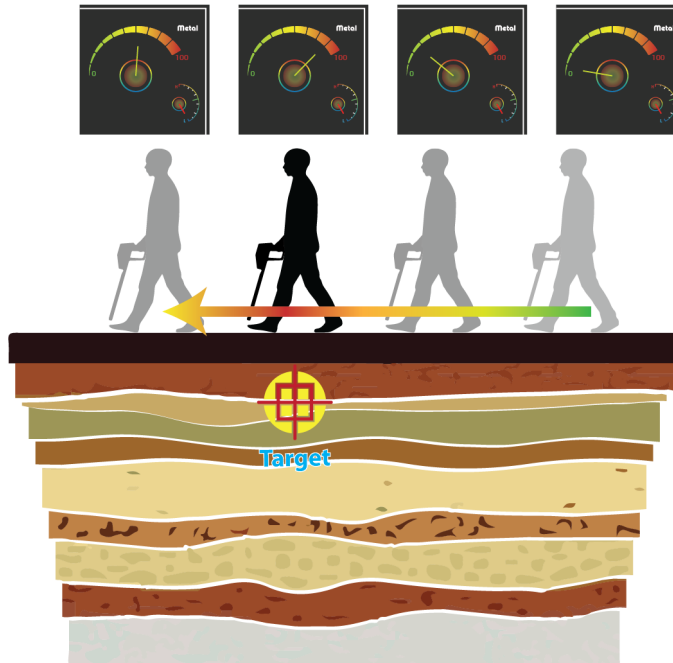

After performing the balance operation, move over the scan area while maintaining an equal distance between the tip of the device and the ground.

While moving over the scan area track the changes on the display in indicator levels and reading intensity to enclose targets.

Change the sensitivity or balance to fine-tune the device to meet the desired configuration.

## Gradio Smart

Once the target point is acquired, select depth meter and press .

Stand over the target and point the device towards the ground, then press the grip key and steadily walk away from the target point.

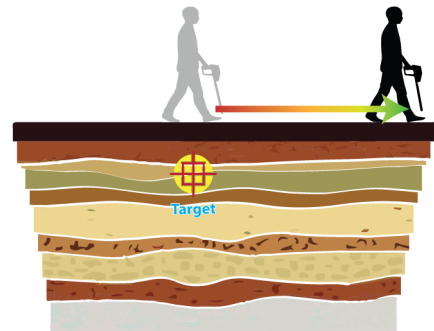
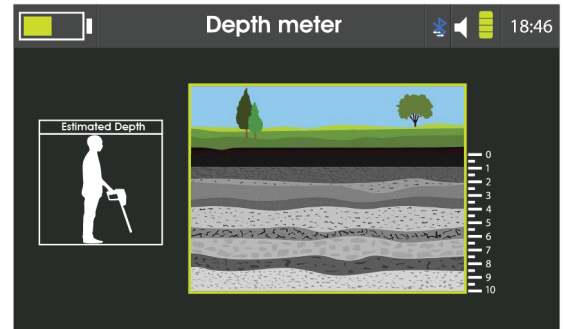

Once the depth measurement is done the device will display the result on the screen.

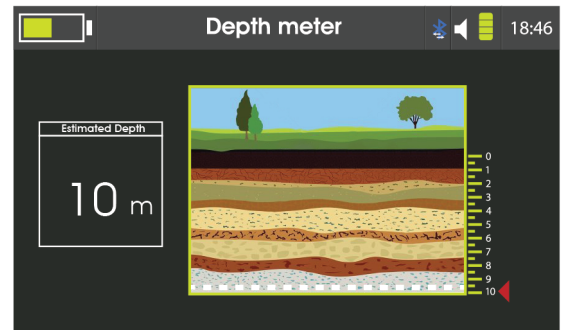

*In case of a failed attempt, go back to target point and repeat the procedure again.*



## Live Scan

---

To enter the Live Scan search system interface, select Live Scan icon from the Main Menu and

press .

Make sure that the device is assembled as in “figure 4 -Gradio Smart Assembly” on page 21 for using the Gradio Smart sensor, or as in “figure 2 -Imaging Scanner Assembly” on page 17 for using the Imaging Scanner.

Imaging Scanner mode:

A balancing operation is required before the start of the search in order to nullify external environmental factors.

Refer to page (38) for info.

After performing the balance operation, move over the scan area while maintaining an equal distance between the bottom of the imaging scanner and the ground.

Press the grip key to pause and resume the scan. The scan speed can be adjusted by the bar on the left to 10 different values.

For further adjustment the balance can be fine-tuned to nullify undesired spectrum.

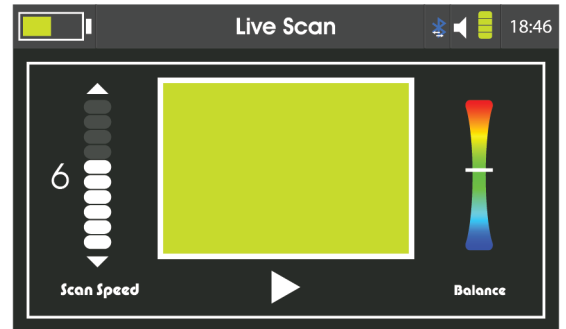
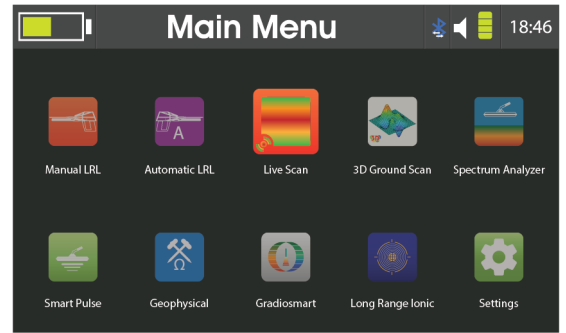



## Live Scan

### Gradio Smart mode:

A balancing operation is required before the start of the search in order to nullify external environmental factors.

After performing the balance operation, move over the scan area while maintaining an equal distance between the tip of the device and the ground.

Press the grip key to pause and resume the scan. The scan speed can be adjusted by the bar on the left to 10 different values.

For defining a specified spectrum adjust **Balance** and **Gain** to get the desired spectrum required for the search requirements.

A message will prompt the user to connect one of the search modules in case no search module was connected.

The device will go into **Imaging Scanner** or **Gradio Smart** mode according to the connected module.

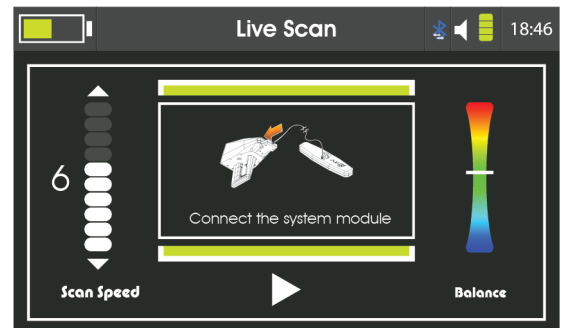
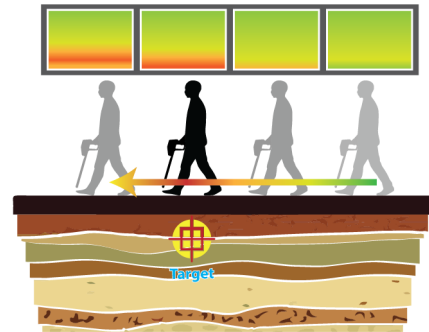
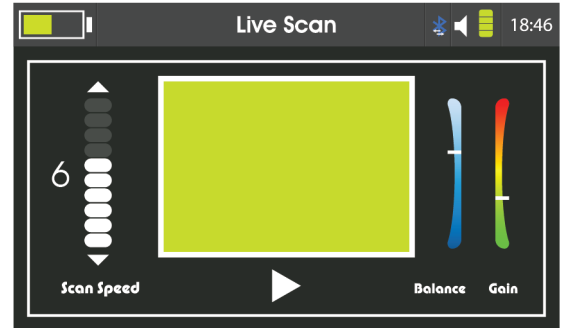

## Ionic Long-Range

Select  from the Main Menu.

The High Gain Antenna must be connected first to proceed to the search interface.

Assemble the High Gain Antenna as shown in “figure 5 -High Gain Antenna Assembly” on page 22.

After connecting the High Gain Antenna, the display will show the search interface.

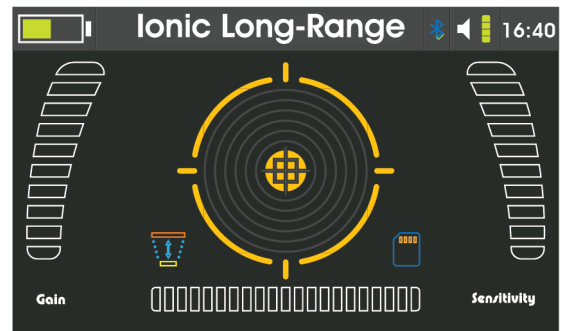
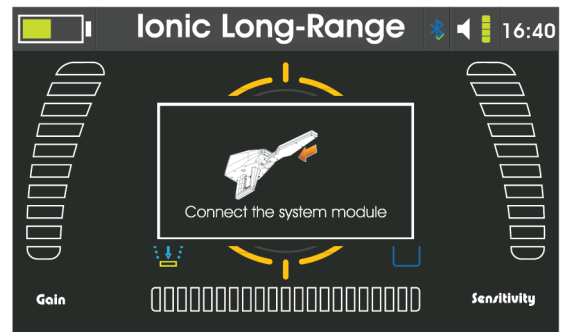
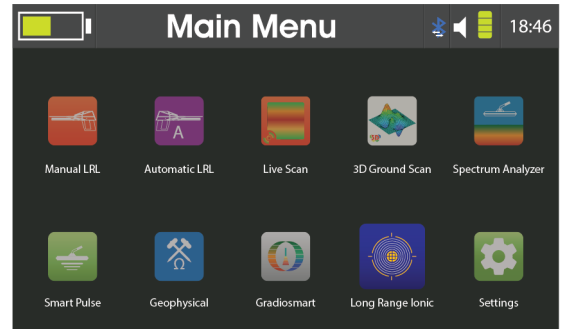

# Ionic Long-Range

---

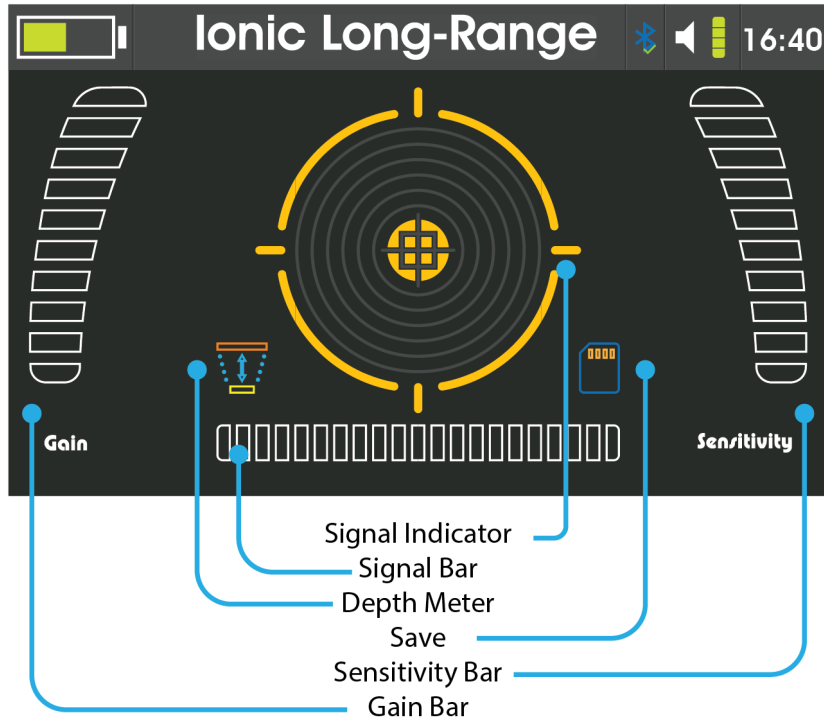

## Starting the Search

---

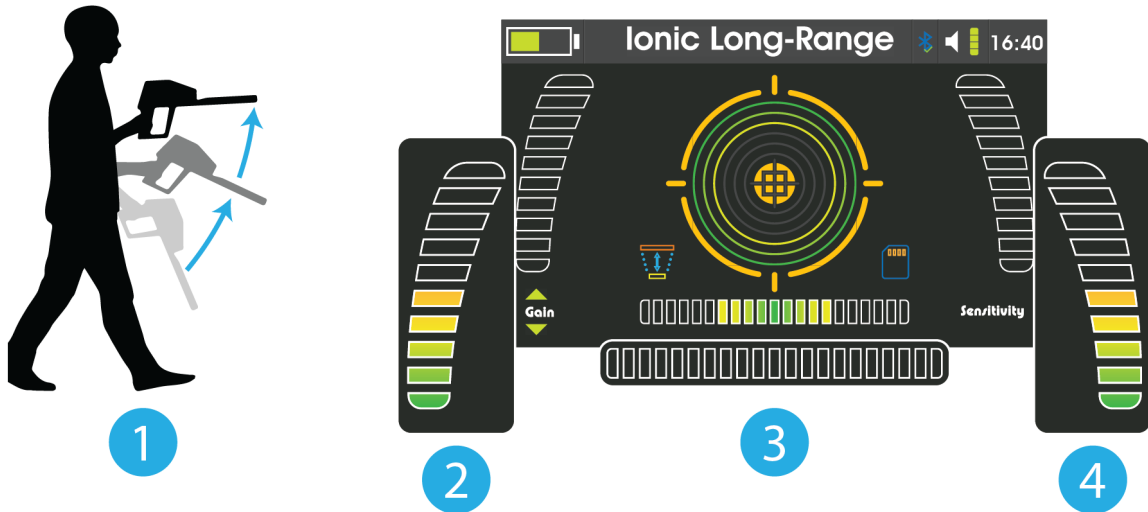

The device should be balanced with the ground value before proceeding into the search.

1- Lift the device in a horizontal position to the ground.

*Don't move during the balance process.*

2- Increase Gain value and notice the changes on the signal bar.

3- Keep increasing the gain bar value until the signal bar is stably set back to the middle and the tone stops.

4- Move the cursor over to sensitivity and increase the bar value to the middle.

*The sensitivity level can be increased or decreased according to the regional conditions.*

Then point the device towards target direction to hear the signal effect on the device.

If the signal is weak and slow, increase the sensitivity until the signal is clear.

The tone speed will increase as the target gets closer.

## Ground Balance

---

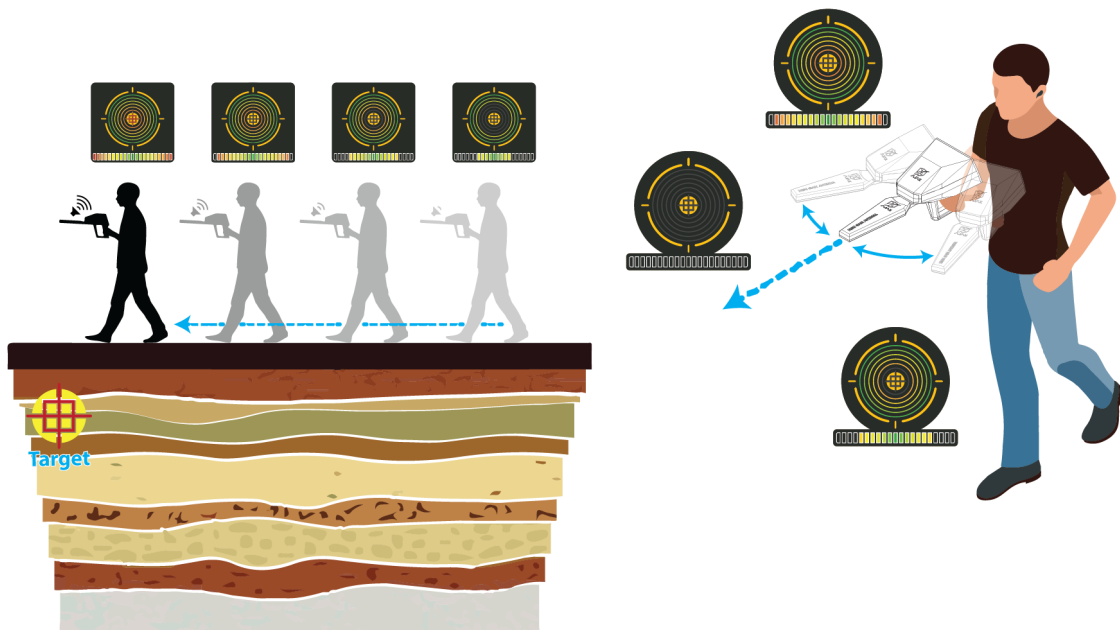

Hold the device horizontally and move it right and left until a signal indicating a probable target is received.

Then track that signal by moving towards target and watching the device display.

Note that the closer to target the device is the more rings will light up on screen and the sound will increase as well. The bottom indicator shows the received signal intensity. The rings will light gradually as the distance to the target decreases.

The indicator in the middle 🌐 will light up when the highest of signal occurs.

## Locating Target point and checking target

---

To locate the target exact point, move the device up and down while performing the tracking process. That will identify the signal direction which provides the right tracking path to the target point.

For a more accurate target point locating, stand over the probable target point and aim the device towards the target. Then move forward until passing the target point, which will be indicated by a drop in the signal intensity on the device display.

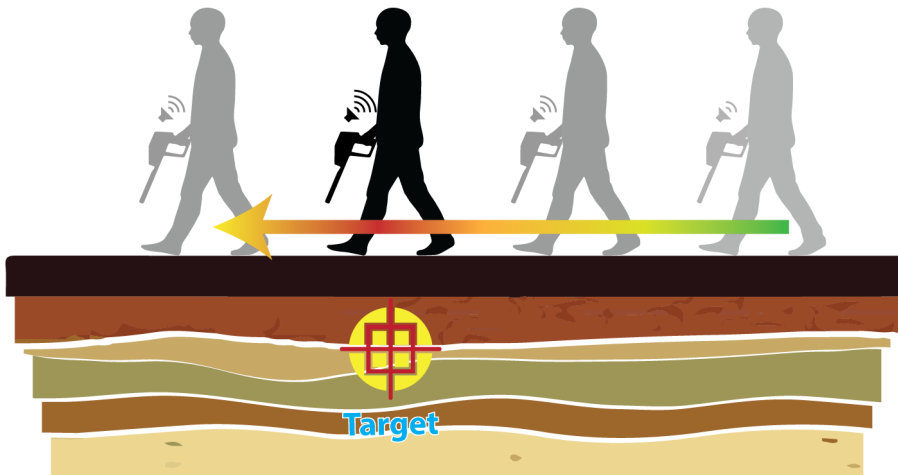
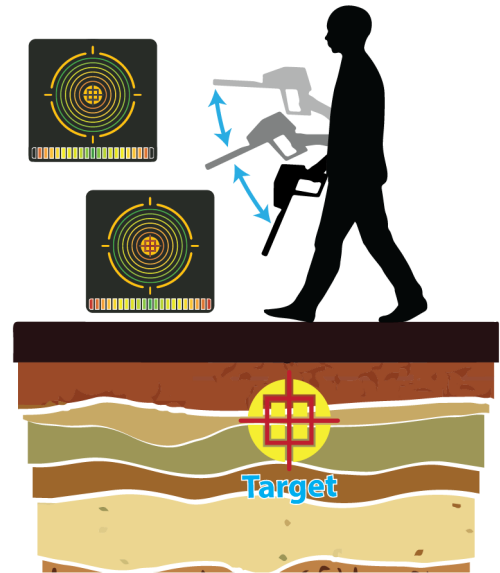

## Locating Target point and checking target

---

Repeat this process from four different directions to identify the probable target borders and enclose it more accurately.

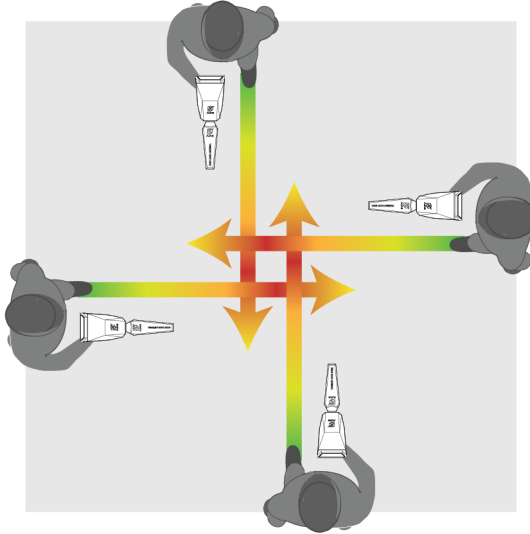

Once the target point is enclosed and located, mark it and proceed to the Depth measuring process next.

## Depth Measuring

After locating the target position by received signals intensities.

1- Select Depth icon on the search display .

2- After accessing Depth meter interface, a screen will prompt pressing the grip key.

3- Point the device vertically towards the ground and press the grip key once then start walking straight forward until the tone from the device indicates the end of the depth measuring process.

4- The device processes the static electricity intensities of target ions. And based on that, the results will show the estimated depth value.

5- The depth meter interface shows an illustration for the ground levels up to 20m.

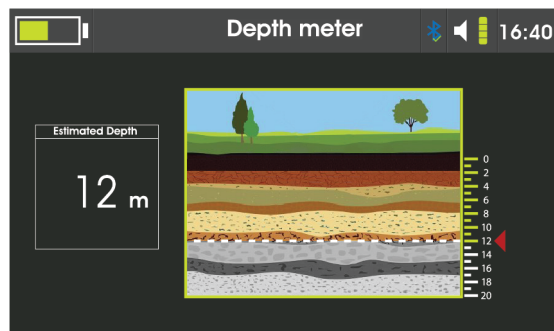
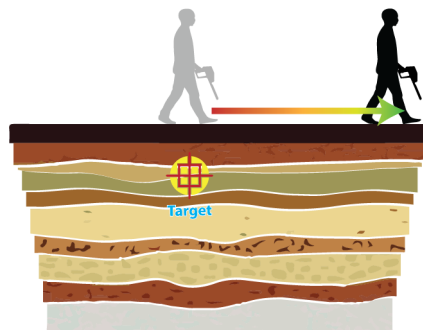
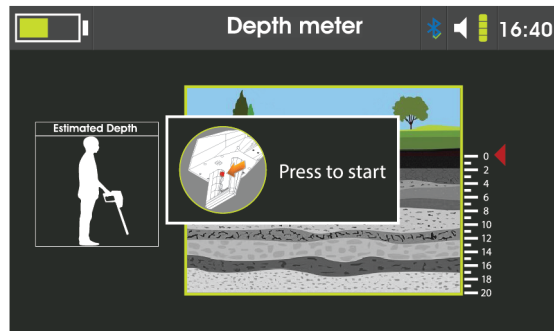

After the measuring process is finished a line will show the determined depth and the value will be shown in the designated box.





## Save

---

Select save icon  on the search interface and press  to take the results on display and store them in the device memory for future use. The result contains the Gain and Sensitivity levels as the signal intensity along with the date and time.

To view saved results, go to settings then storage and select the system, a list of the previously saved results will be shown.

The results can be viewed or deleted.

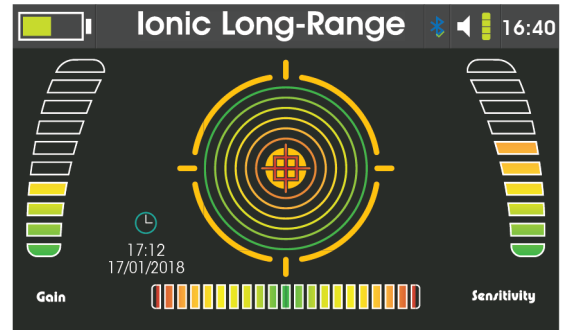

This page is left blank intentionally.

---

## Search Coils

---



C1 Search coil provides the required accuracy for the device to pick up on small and tiny objects and targets. With its light weight and small footprint it is the best tool for long search and tracking processes.

C2 Search coil is the balance between depth and sense, making it the ideal search for different terrains and search areas whether the objects are located deep in ground or closer to surface without losing the signal strength or sense.

C3 Search coil is the depth tool for this device with its rectangular design it covers more surface area with extended depths of search to locate large and deep target.

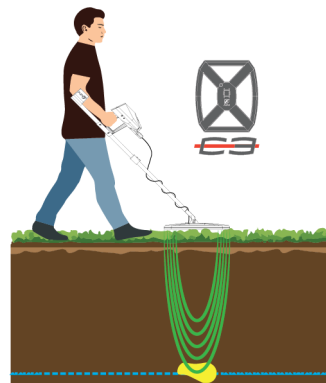
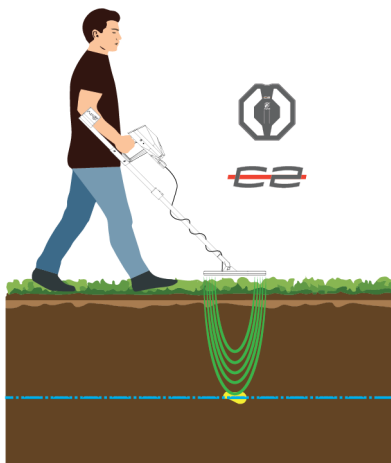

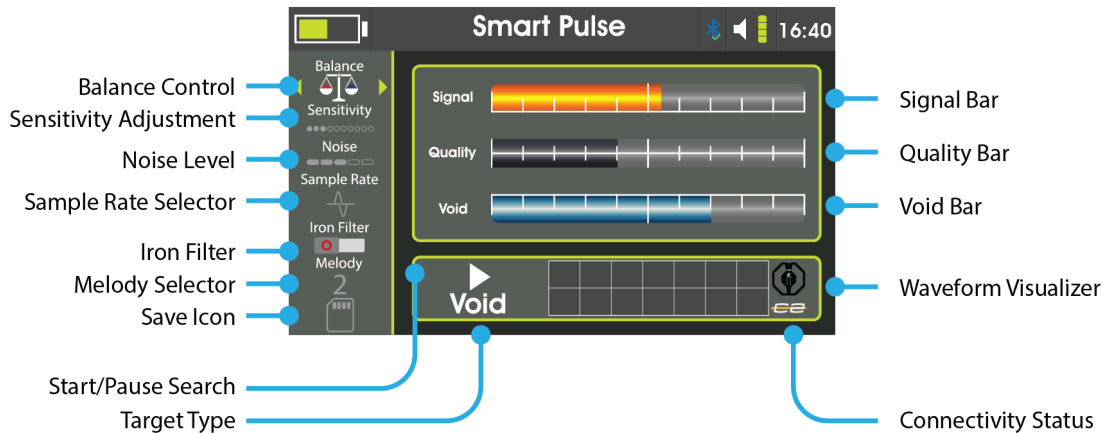

## Smart Pulse



Assemble the device as shown in “figure 3 -Search Coil Assembly” on page 19  
-Select Smart Pulse from the Main Menu.  
The device shows the search interface which contains:

### Balance Control:

Press  to reset the bars to the initial values and balance them on the ground. The balance can be further adjusted by pressing   for fine tuning and more control over the balance process.

### Sensitivity Adjustment:

This adjustment sets the device respond to small or deep target, so it is recommended to increase it as long as the signal is stable.

### Noise Level:

It controls the quality of the signal. It is also recommended to be increased as long as the bars are stable.

### Sample Rate Selector:

This setting adjusts the number of samples taken to process. It does not need a change from its initial value unless there is another device in the search area.

### Iron Filter:

This setting disable the audio feedback for the iron based metals. So the user can ignore these kinds of targets.

## Smart Pulse

---

### Melody Selector:

Selects the audio feedback melody of the device.

### Save Icon:

Press  to save the values shown on the screen into storage for further review.

### Signal Bar:

This bar fills when the pulse from the search coil is further induced by a target. The larger or closer the target is the more the bar fills.

### Quality Bar:

This shows the quality of the signal received, if the quality of the signal is high enough then the device will process the target type accordingly.

### Void Bar:

This shows the induced signal by underground hollow pockets and cavities/voids.

### Target Type:

Shows the detected signal type for the target.

### Waveform Visualizer:

It stores and shows the recent activity of the search.

### Connectivity Status:

This icon displays the current attached search coil or if there is disconnection in the connection module or the search coil.

### Start/Pause Search:

Press the Grip key to Pause/Start the search.

#### *Note:*





The device needs to be rebalanced after adjusting any of the parameters.

## Smart Pulse

---

Hold the device as shown in the figure on right.

Put the search coil on the ground and press the Grip key to start the search.

The device needs to be balanced first. To balance the device press  over  so the bars on the right are all reset to the initial values. If a static signal is still picked up by the device it can be fine tuned by pressing   over .

Once the device is balanced and all the bars on the right are empty, lift the device 3-5 cm off the ground and move it over the search area in a sweeping motion left and right in a medium pace. Keep the search coil parallel to the ground during the search for maximum performance and accurate results.

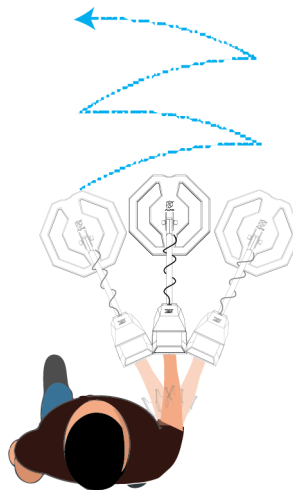
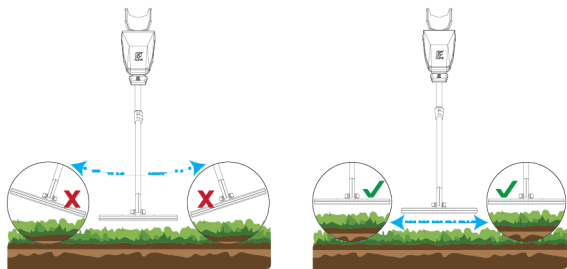

## Smart Pulse

---

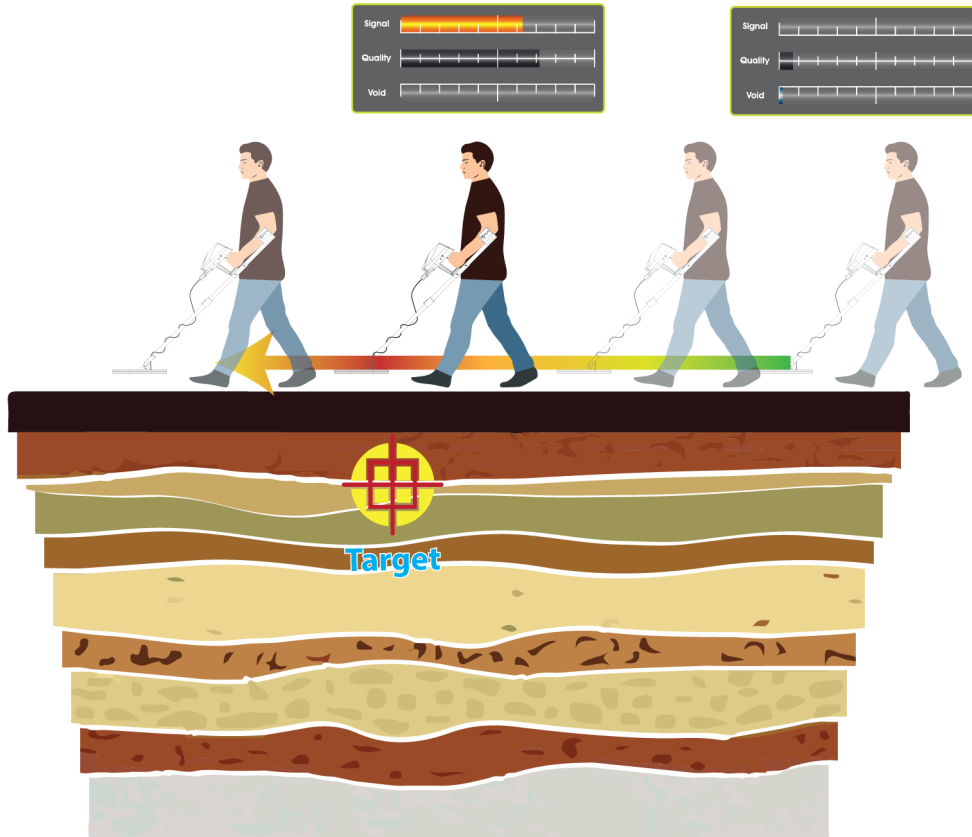

While moving over the scan area track the changes on the display in the Signal, Quality and Void levels and reading intensity to enclose targets.

Change the sensitivity or balance to fine-tune the device to meet the desired configuration.

## Spectrum Analyzer

This system takes a criss-cross reading of the target and analyze the data then visualizes the result in a 3D plotted surface on the interface representing the depth and signal strength over the search area.

Assemble the device as shown in “figure 3 -Search Coil Assembly” on page 19.

Select Spectrum Analyzer from the Main Menu.

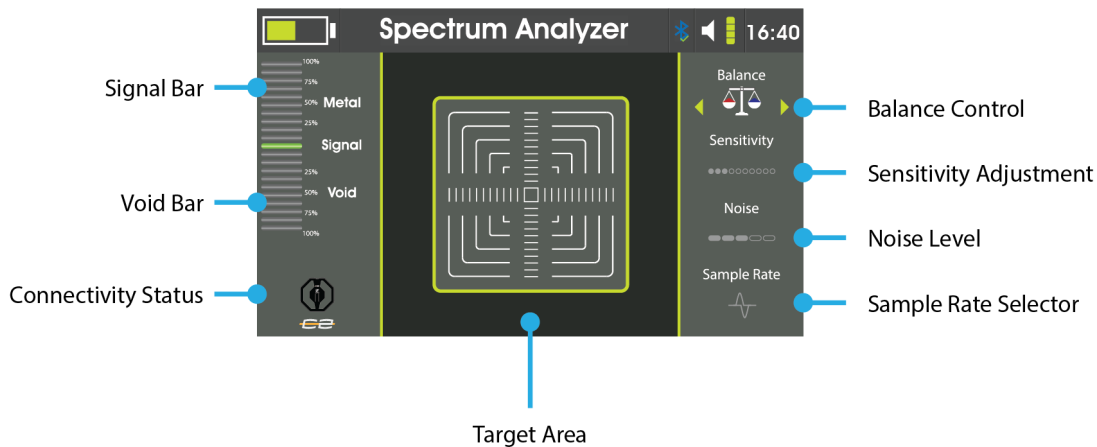
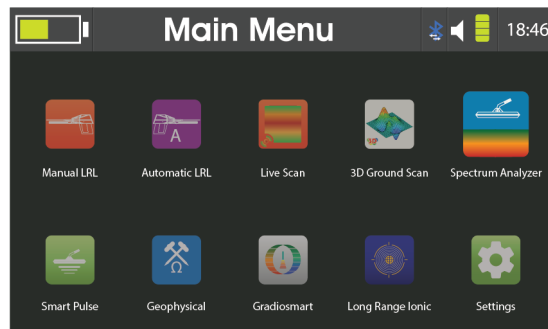





# Spectrum Analyzer

---

## Balance Control:

Press  to reset the bars to the initial values and balance them on the ground. The balance can be further adjusted by pressing   for fine tuning and more control over the balance process.

## Sensitivity Adjustment:

This adjustment sets the device respond to small or deep target, so it is recommended to increase it as long as the signal is stable.

## Noise Level:

It controls the quality of the signal. It is also recommended to be increased as long as the bars are stable.

## Sample Rate Selector:

This setting adjusts the number of samples taken to process. It does not need a change from its initial value unless there is another device in the search area.

## Signal Bar:

This bar fills when the pulse from the search coil is further induced by a target. The larger

or closer the target is the more the bar fills.

## Void Bar:

This shows the induced signal by underground hollow pockets and cavities/voids.

## Connectivity Status:

This icon displays the current attached search coil or if there is disconnection in the connection module or the search coil.

### Note:

If a Smart Pulse search was conducted prior to the Spectrum Analyzer, the Sensitivity, Noise and Sample Rate values are carried into Spectrum Analyzer from the Smart Pulse system.

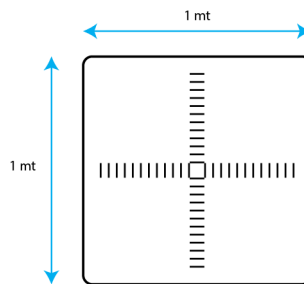

The device needs to be rebalanced after adjusting any of the parameters.

The Target area is optimized to be 1 meter by 1meter.



## Spectrum Analyzer

Adjust the balance so the device is idle out of the target area.

Press the grip key to move to the target area. Select the starting position by pressing . Put the search coil at the edge of the target area and press  and move the search coil over the target area as it shown on the interface.

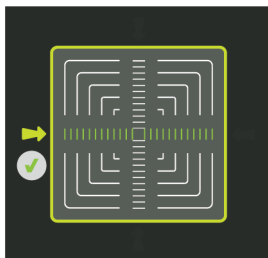
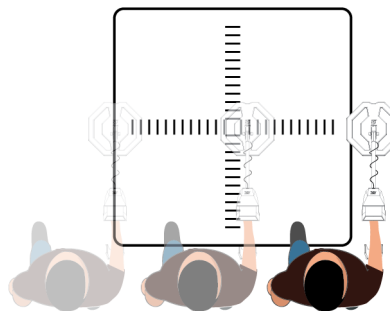
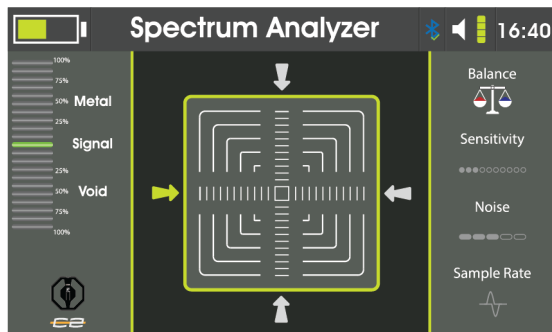
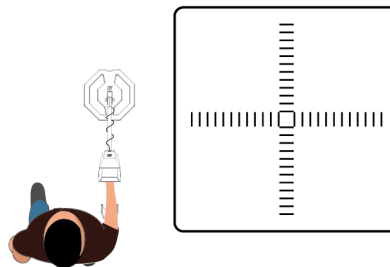

## Spectrum Analyzer

Repeat the process for all the sides.  
Once all the readings are taken the device will process them into a final 3D plotted surface representing the Signal strength and width.

The final result interface shows the target type and estimated depth.

Then the user can save the result or restart the scan again.

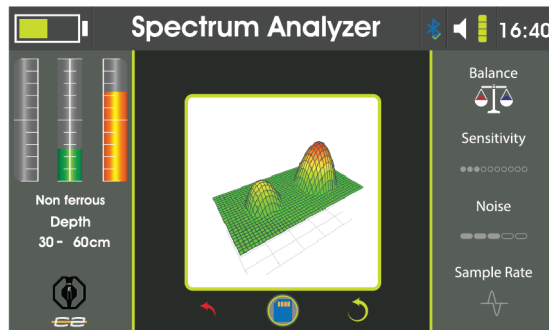
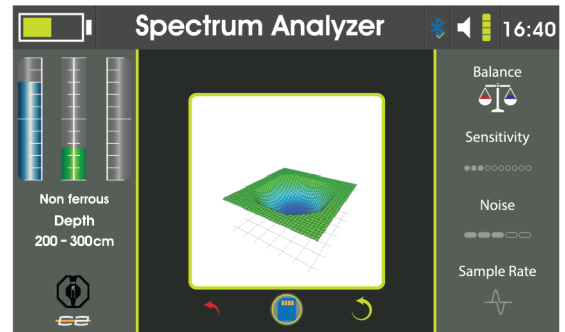
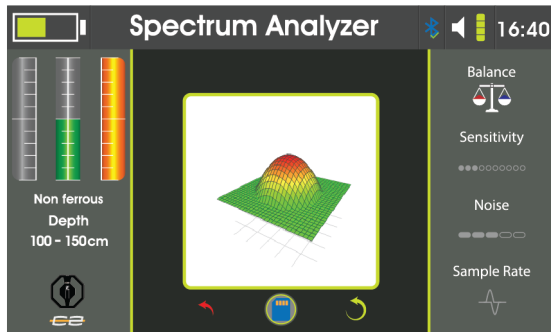
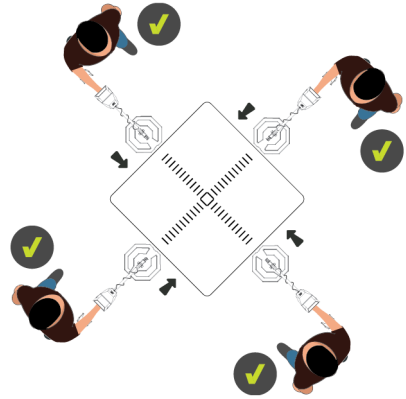

# Long-Range Locator

The device can be used with the following two systems:

1.  Manual Long-Range Locator system:  
The term manual describes the user ability to adjust the search parameters manually to fit the needed requirements of the search, Where the target type can be set from the list in addition to the other parameters as the frontal search distance, and the depth.

2.  Automatic Long-Range Locator system:  
• The device has Automatic Detection System for the located targets and shows the target type on display automatically, and calculating the target distance from the device with high precision.  
• The user can also determine the depth after acquiring the target location automatically.  
• The device provides the user with a comprehensive report regarding the search process with the ability to save the report for review.

*The High Gain Antenna and Roaming Antennas must be connected first to proceed to the search interface.*

*Assemble the High Gain Antenna as shown in “figure 5 -High Gain Antenna Assembly” on page 22.*

*Assemble the Roaming Antennas as shown in “figure 6 -Roaming Antennas Assembly” on page 23.*

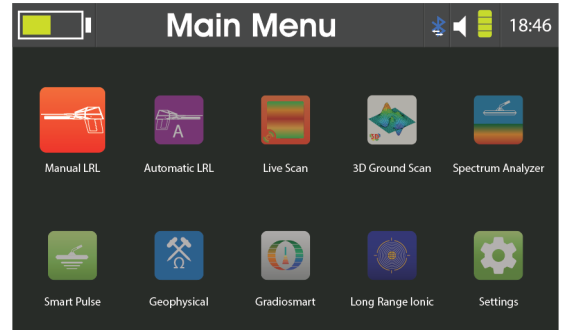

## Manual Long-range Search

After selecting the system, the interface shows the search parameters, which are:

### 1. Target:

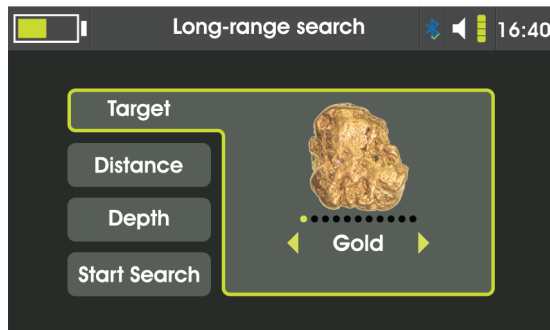

There are multiple targets to choose from (Gold, Gold Nugget, Silver, Copper, Bronze, Iron, Tin, Lead, Aluminium, Meteorite, Diamond, Emerald, Water and Cavity).

The target can be selected using  .



### 2. Search Distance:

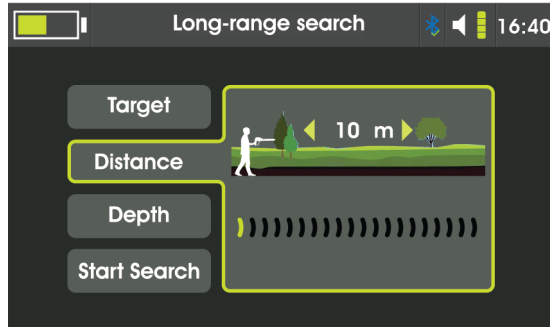

Starts from 100 meters up to 2250 meters.

It can be set using  .



### 3. Depth:

Starts from 1 meter up to 50 meters.

It can be increased or decreased using  .

### 4. Start Search:

Displays an overview of the search parameters.

Press  to proceed to the search interface.

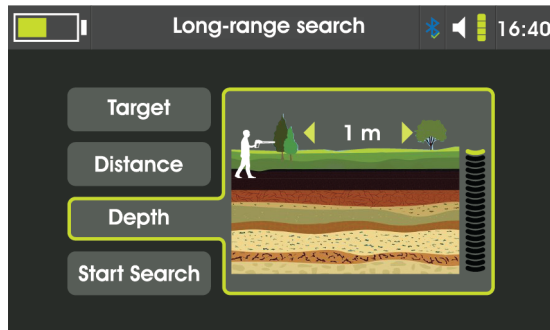
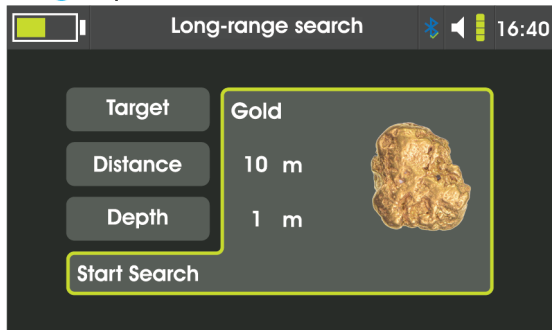

## Manual Long-range Search

An illustration shows the proper way to hold the device, which is upright and parallel to the ground while keeping the roaming antennas on the middle.

After holding the device properly press  or the Grip Key.

The search interface consists of the following objects:

1. Waveform window shows the signal frequency output operating and transmitting correctly.

2. The compass shows the device current direction.

3. Inclination indicator shows the holding position of the device during the search process, so the user could keep it at the green range.

4. Target information box shows the selected search parameters.

5. Save icon is to store the current search information for review.

6. Roaming Antennas indicator shows the current position of the antennas relative to the device.

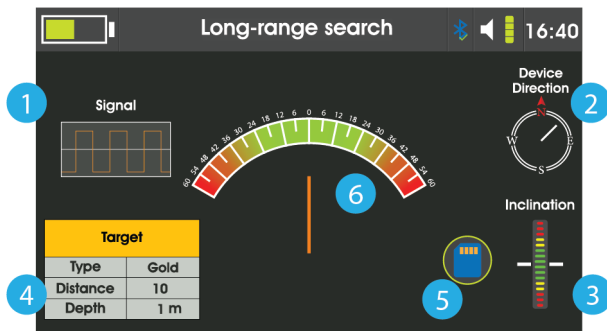
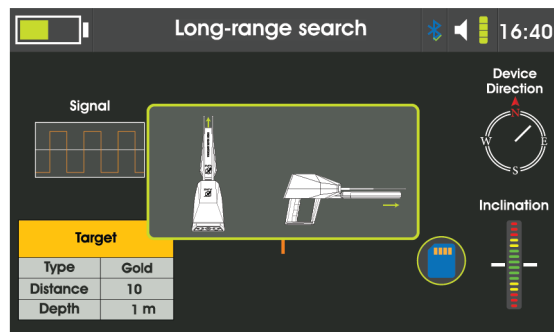
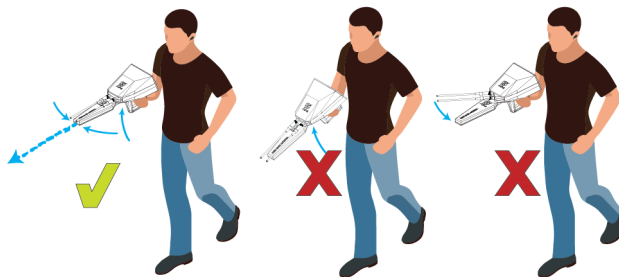

## Manual Long-range Search

Working and locating targets using the system:

- The device needs to be balanced and held correctly.
- The tracking indicator will be shown in the middle of the interface.
- Hold the device until a signal is received indicated by the antennas moving from the balanced position towards another direction.
- The user turns with the antennas pointing towards the new path direction.
- Reset the tracking indicator by pressing the grip key, initializing the indicator back to the middle.
- If the antennas stay on the same path then the target path is correct.
- If the antennas turned towards another direction the user should repeat the previous steps again.
- After that, the user can walk to track the target path and locate it.

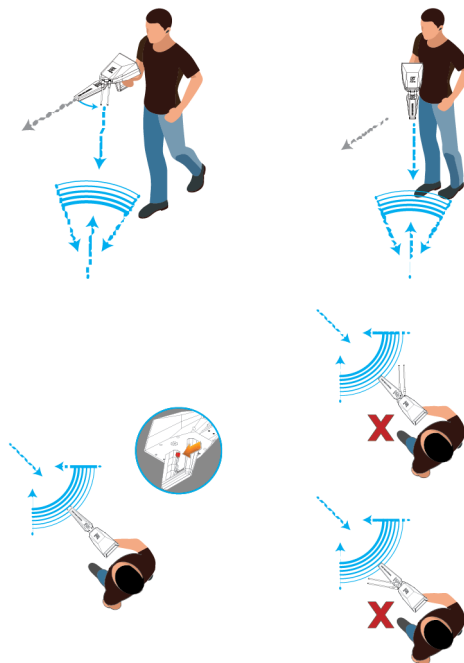
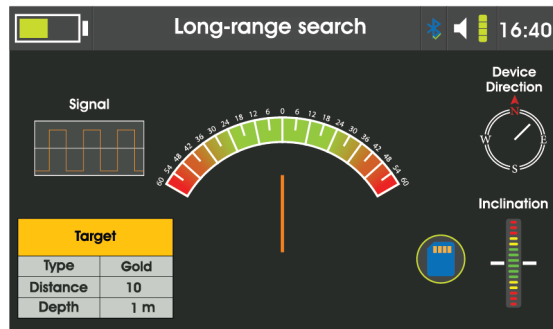

## Manual Long-range Search

- Press the grip key once to display the target indicator which is a rhombus in top center of the interface.

- The device makes interactive sounds towards the target direction. Walk toward it.

- If the antennas turn away slightly from the correct path left or right, the display show arrows, guiding the user to adjust the direction on a straight course.

- Once the target point is passed, the antennas will turn all the way left or right, then the user should stop and this is the first stop.

- Rotate with the antennas movement to track the new path.

- The antennas will stabilize on the same first path line but in the opposite direction. Keep walking down this direction until the antennas turn again. Here the user should stop again and this is the second stop.

- The target point is the midpoint between the first and second stop.

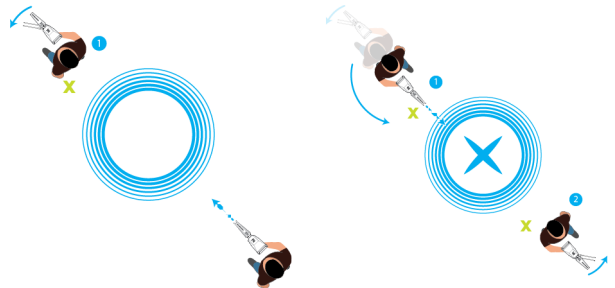
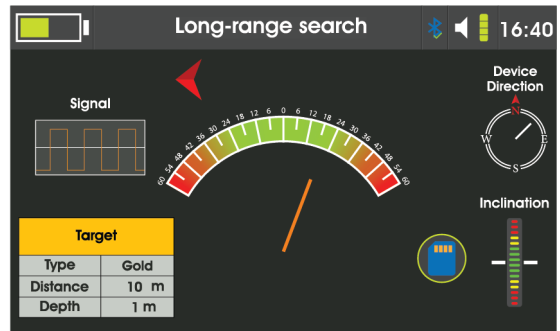
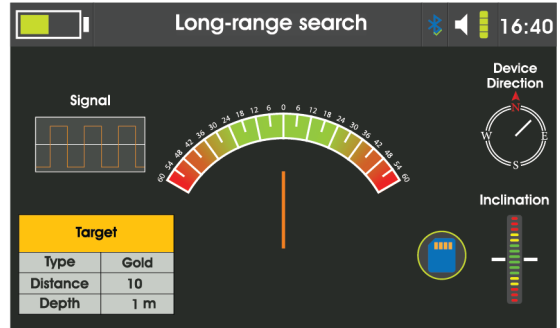



## Auto Long-range Search

Select the Long-range Auto search from the Main Menu.

An illustration shows the proper way to hold the device, which is upright and parallel to the ground while keeping the roaming antennas on the middle.

After holding the device properly press  or the Grip Key.

The interface shows:

- 1• Search indicator in the middle of the interface.
- 2• Compass showing the current device direction.
- 3• Balance indicator shows the holding position of the device during the search process, so the user could keep it at the green range.
- 4• Interactive target detection indicator.
- 5• Search phases and current phase.

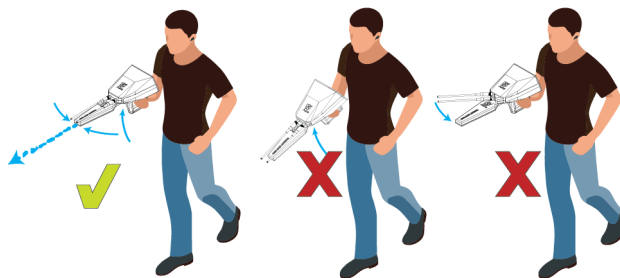
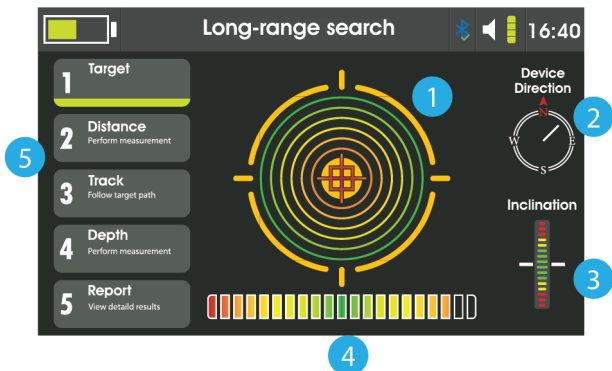
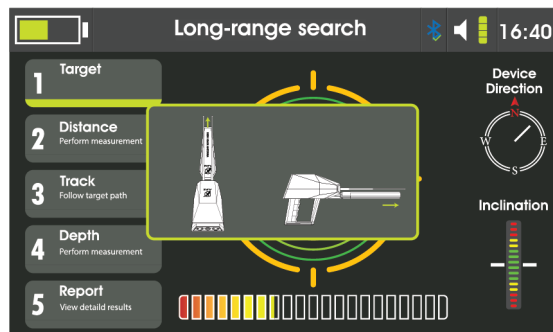
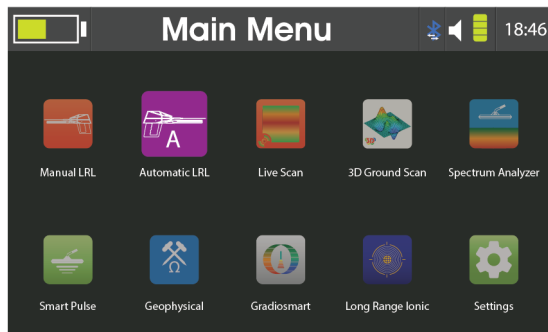



## Auto Long-range Search

Face the targeted search area and wait for the device to receive a signal indicated by the antennas moving towards targets directions.

Then turn with the antennas, in the meanwhile, wait for the interactive meter to finish the evaluation and detection process.

The interface shows the found target or targets in the search area.

To list the detected targets, press  or  keys to see the target types.

Select one of the detected targets to locate its position and measure its distance.

When the target is selected from the list of detected targets the interface proceeds to the next phase in the system, which is the distance measuring.

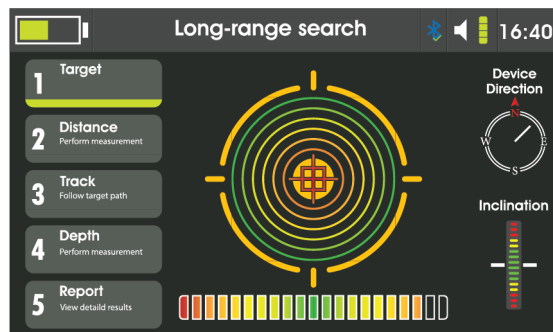

## Auto Long-range Search

Notice that the device making a sound notification when it is pointing toward the selected target direction.

This point and direction are the start point and direction for target measuring distance.  
Target Distance Measuring:

When the device is aimed towards the target and it is making a notification sound, the direction must be sustained.

- Here, the start point should be selected. Either left or right of the current point.

- Press  and the arrow shows a prompt for moving 25 meters left or right depending on the selection.

- After walking the 25 meter distance, hold the device and wait for the antennas reading.

- The reading is indicated by the antennas turning towards the target direction and intersecting with the first path.

- If the reading towards the target is noticed, press the grip key to get the target distance.

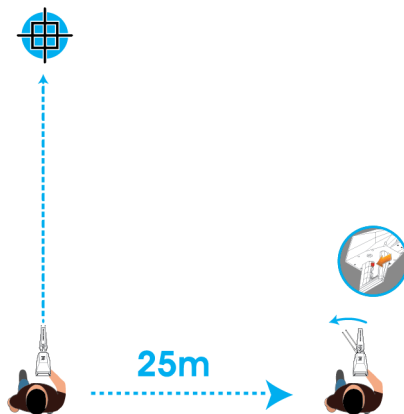
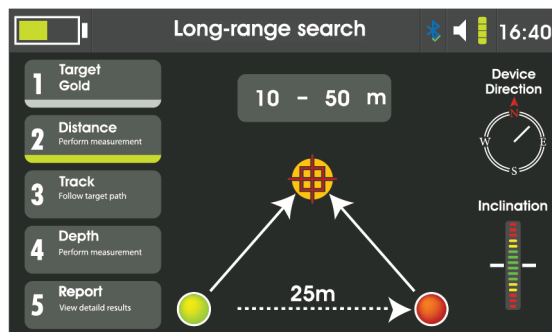
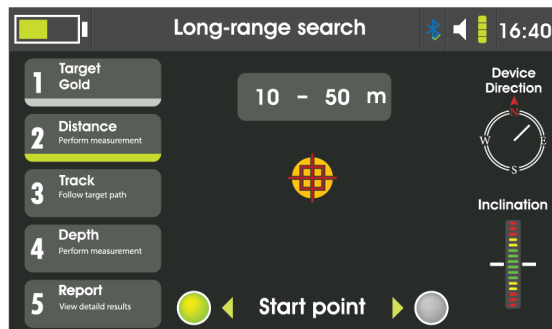

## Auto Long-range Search

- The result will show on the top of the interface. If the result didn't show, then the arrow will blink indicating that the user should move another 25 meters.

- Then press  key to see the arrows forming a triangle with target distance from the search point.

- The interface proceeds to the next phase which is the target tracking.

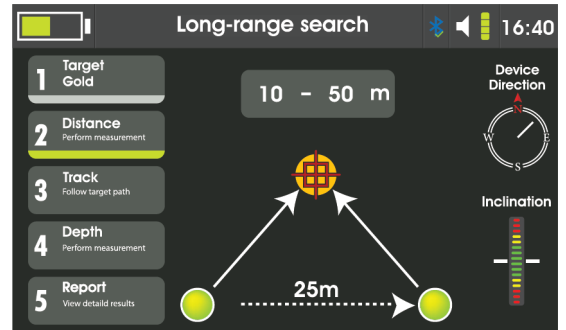

# Auto Long-range Search

## Target Tracking Process

- Sustain the balanced device position.
- The interface shows the signal tracking indicator in the middle.
- Initialize the target direction by pressing the grip key.

Follow the antennas direction. If the antennas stay on that path then the path to the target is correct, but if the antennas change direction; the user should repeat the previous steps.

- Walk to track the target path and locate it.
- The device makes interactive sounds towards the target direction.
- Walk toward it. If the antennas turn away from the correct path slightly to the left or right, the display shows arrows, guiding the user to adjust the direction on a straight course.

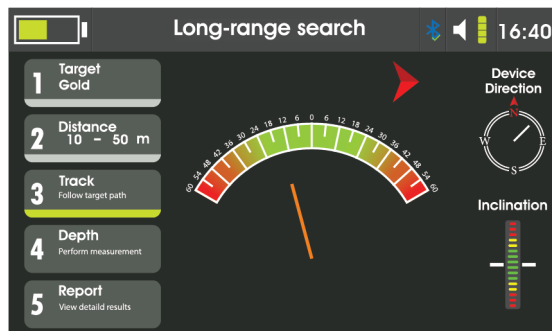
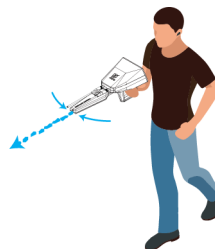
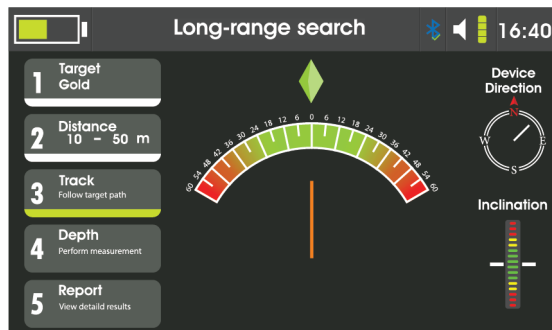

## Auto Long-range Search

---

- Once the target point is passed the antennas turn all the way to the left or right. Then, the user should stop and this is the first stop.
- Rotate with the antennas movement to track the new path. The antennas will stabilize on the same first path line but in the opposite direction.
- Keep walking down this direction until the antennas turn again. Here, the user should stop again and this is the second stop.
- The target point is the midpoint between the first and second halt.
- Once the target tracking phase is finished, the device proceeds to the depth measuring phase.

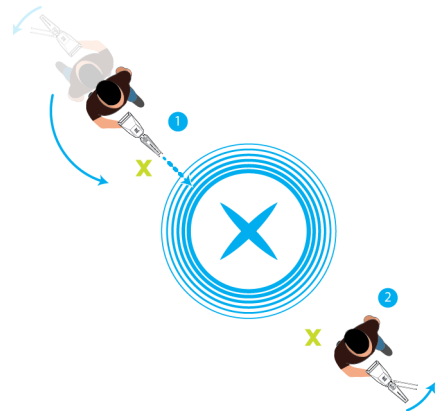
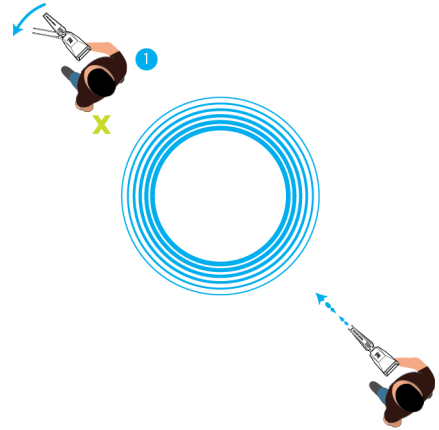

# Auto Long-range Search

Depth measuring process:

The user has to move 5 to 10 meters away from the target point, while the depth measuring interface is ready.

Press the grip key and wait for the antennas reading indicated by pointing towards the target location again.

When the reading is complete, the depth result shows on the interface then the system proceeds to the last stage which is the report.

Report:

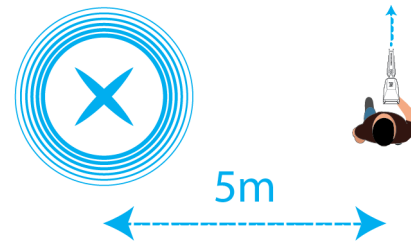
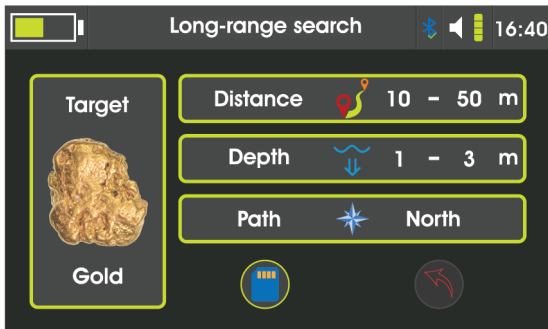
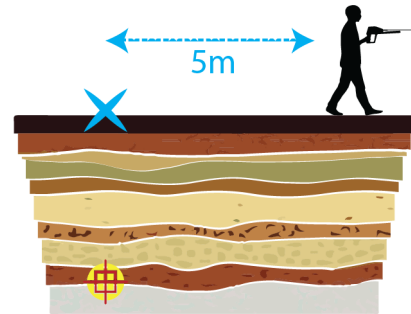

Offers a summary of the search process including the target type, distance, the followed path and depth. The user can save this report in the device storage for later review or discard the report by exiting the interface and confirming the process.



# Geophysical

After selecting the system, the display shows the scan interface.

Plant the probes in the scan area then connect the clips and wire to the probes and System Module. Then connect the system Module to the Main unit.

Select the scan target by pressing   and press  to start the scan. The device can scan for **Gold**, **Silver**, **Copper**, **Brass**, **Iron**, **Water** and **Voids**.

Notice that the connectivity status icon shows if the probes or system connection module disconnected.

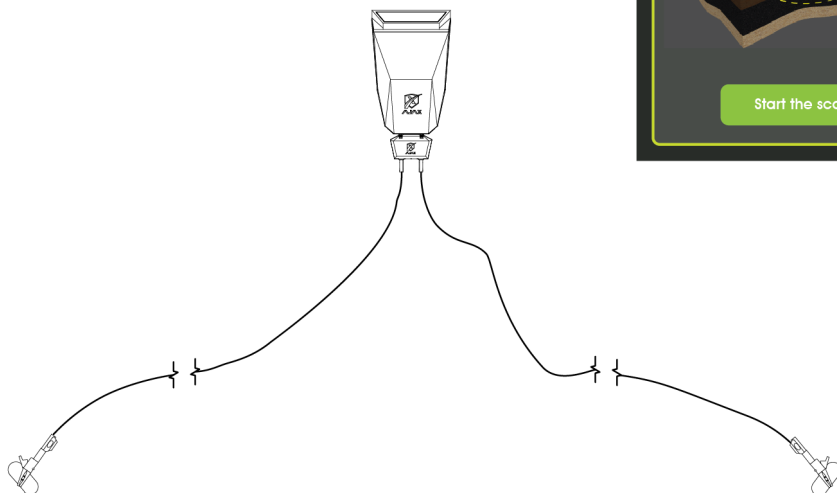
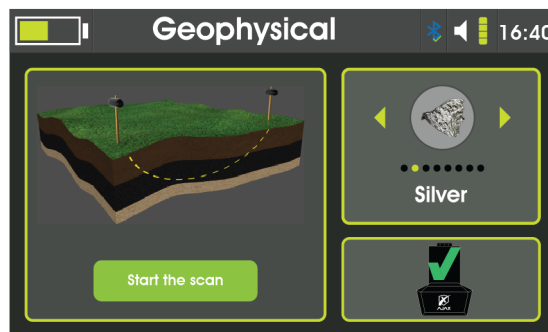
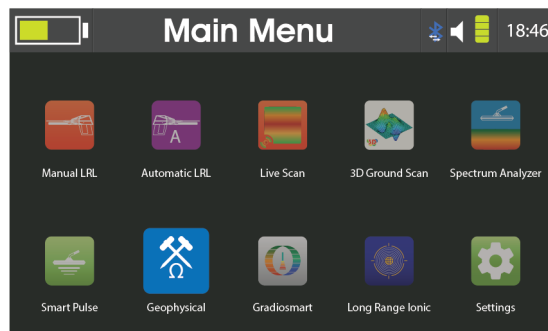



# Geophysical

The device will start the scan process on the area and show the result at the end.  
The result shows both the probability of the target found and the estimated depth.

When the scan is concluded, it can be saved for future review or restarted again.

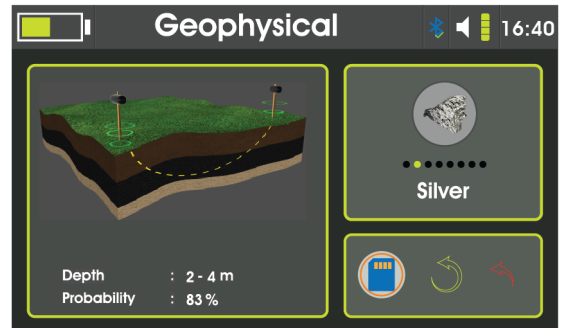

# Battery

---

## Charging the battery

Charge the battery before using it for the first time or when it has been unused for extended periods.

Use only AJAX-approved chargers, batteries, and cables.

Unapproved chargers or cables can cause the battery to explode or damage the device.

- Connecting the charger improperly may cause serious damage to the device.

Any damage caused by misuse is not covered by the warranty.

- Use only cable supplied with the device. The device may be damaged if you use different cable.

To save energy, unplug the charger when not in use.

The charger does not have a power switch, so you must unplug the charger from the electric socket when not in use to avoid wasting power.

The charger should remain close to the electric socket and easily accessible while charging.

**1** Plug the DC cable into the device's Charge jack.

**2** Plug the power adapter into an electric socket.

**3** After fully charging, disconnect the charger from the device.

Then, unplug the charger from the electric socket.

## Precautions for operating environment

Your device may heat up due to the environment in the following conditions.

Use caution to avoid shortening the battery's lifespan, damaging the device, or causing a fire.

- Do not store your device in very cold or very hot temperatures.
- Do not expose your device to direct sunlight for extended periods.
- Do not use or store your device for extended periods in very hot areas, such as inside a car in the summertime.
- Do not place the device in any areas that may overheat, such as on an electric heating mat.
- Do not store your device near or in heaters, microwaves, hot cooking equipment, or high pressure containers.
- Never use a damaged charger or battery.

# Battery

---

## Battery charging tips and precautions

- When the battery power is low, the battery icon appears empty.
- If the battery is completely discharged, the device cannot be turned on immediately when the charger is connected. Allow a depleted battery to charge for a few minutes before turning on the device.
- The device can be used while it is charging, but it may take longer to fully charge the battery.
- If the device receives an unstable power supply while charging, the device may not function. If this happens, unplug the charger from the device.
- While charging, the device and the charger may heat up. This is normal and should not affect the device's lifespan or performance. If the battery gets hotter than usual, the charger may stop charging.
- If the device is not charging properly, take the device and the charger to AJAX or an AJAX Authorized Service Centre.

## Contact Information

---

### AJAX DETECTION TECHNOLOGY LTD.

Address 1201 N.W. Briarcliff Parkway, 2nd Floor,  
Kansas City, Missouri, 64116 USA

Telephone +1 816 298 0485  
+1 816 399 3744

E-mail [info@ajaxdetection.com](mailto:info@ajaxdetection.com)  
Web site <http://www.ajaxdetection.com>



## WEEE (Waste Electrical and Electronic Equipment) Statement

---

To protect the global environment and as an environmentalist, AJAX must remind you that... Under the European Union ("EU") Directive on Waste Electrical and Electronic Equipment, Directive 2002/96/EC, which takes effect on August 13, 2005, products of "electrical and electronic equipment" cannot be discarded as municipal waste anymore, and manufacturers of covered electronic equipment will be obligated to take back such product at the end of their useful life. AJAX will comply with the product take back requirements at the end of life of AJAX-branded products that are sold into the EU. You can return these products to local collection points.

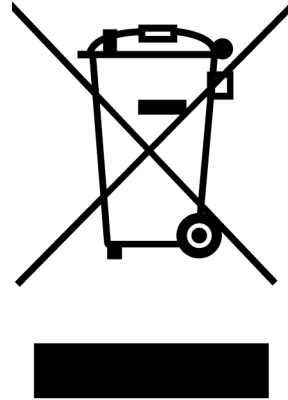

### Environmental Policy

The product has been designed to enable proper reuse of parts and recycling and should not be thrown away at its end of life.

Users should contact the local authorized point of collection for recycling and disposing of their end-of-life products.

Visit the AJAX website and locate a nearby distributor for further recycling information.

Users may also reach us at <envo@ajaxdetcor.com> for information regarding proper Disposal, Take-back, Recycling, and Disassembly of AJAX products.



## WEEE (Waste Electrical and Electronic Equipment) Statement

---

European Union:



Batteries, battery packs, and accumulators should not be disposed of as unsorted household waste. Please use the public collection system to return, recycle, or treat them in compliance with the local regulations.

Taiwan:

廢電池請回收



For better environmental protection, waste batteries should be collected separately for recycling or special disposal.

California, USA:



The button cell and Li-ion battery may contain perchlorate material and requires special handling when recycled or disposed of in California.

For further information please visit:

<http://www.dtsc.ca.gov/hazardouswaste/perchlorate/>



**AJAX**  
DETECTION TECHNOLOGY

[www.ajaxdetector.com](http://www.ajaxdetector.com)